

Automation systems Drive solutions

Controls

Inverters



Motors

Gearboxes

Engineering Tools

Contents of the L-force catalogue

About Lenze		Lenze makes many things easy for you. A matter of principle: the right products for every application. L-force product portfolio			
Automation systems		Controller-based Automation	1.1		
		Drive-based automation	1.2		
Drive solutions		HighLine tasks	2.1		
		StateLine tasks	2.2		
		Baseline tasks	2.3		
Controls	Cabinet Controller	Controller 3200 C	3.1		
		Controller c300	3.2		
	Panel Controller	Controller p500	3.3		
		Controller p300	3.4		
		I/O system 1000	3.5		
		Monitor Panel	3.6		
Inverters	Decentralised	Inverter Drives 8400 protec	4.1		
		Inverter Drives 8400 motec	4.2		
	Cabinet	Servo Drives 9400 HighLine	4.4		
		Inverter Drives 8400 TopLine	4.5		
		Servo Inverters i700	4.6		
		Inverter Drives 8400 HighLine	4.7		
		Inverter Drives 8400 StateLine	4.8		
		Inverter Drives 8400 Baseline	4.10		
		Motors	Servo motors	MCS synchronous servo motors	5.1
				MD□KS synchronous servo motors	5.2
MQA asynchronous servo motors	5.3				
MCA asynchronous servo motors	5.4				
Three-phase AC motors	MF three-phase AC motors		5.5		
	MH three-phase AC motors		5.6		
	MD three-phase AC motors		5.7		
	m300 Lenze Smart Motor		5.8		
	MD/MH basic three-phase AC motors		5.9		
	Gearboxes		Axial gearbox	g700-P planetary gearbox	6.1
				MPR/MPG planetary gearboxes	6.2
g500-H helical gearbox		6.3			
GST helical gearboxes		6.4			
g500-S shaft-mounted helical gearbox		6.5			
GFL shaft-mounted helical gearboxes		6.6			
Right-angle gearbox		g500-B bevel gearbox	6.7		
		GKR bevel gearboxes	6.8		
		GKS helical-bevel gearboxes	6.9		
		GSS helical-worm gearboxes	6.10		
Motor data		Assignment see above	6.11		
Engineering Tools			Navigator	7.1	
			Drive Solution Designer	7.2	
		Drive Solution Catalogue	7.3		
		Engineer	7.4		
		PLC Designer	7.5		
		VisiWinNET®	7.6		
		EASY Starter	7.7		

 Selected portfolio
 Additional portfolio

Lenze makes many things easy for you.

With our motivated and committed approach, we work together with you to create the best possible solution and set your ideas in motion - whether you are looking to optimise an existing machine or develop a new one. We always strive to make things easy and seek perfection therein. This is anchored in our thinking, in our services and in every detail of our products. It's as easy as that!

1

Developing ideas

Are you looking to build the best machine possible and already have some initial ideas? Then get these down on paper together with us, starting with small innovative details and stretching all the way to completely new machines. Working together, we will develop an intelligent and sustainable concept that is perfectly aligned with your specific requirements.

4

Manufacturing machines

Functional diversity in perfect harmony: as one of the few full-range providers in the market, we can provide you with precisely those products that you actually need for any machine task – no more and no less. Our L-force product portfolio, a consistent platform for implementing drive and automation tasks, is invaluable in this regard.

2

Drafting concepts

We see welcome challenges in your machine tasks, supporting you with our comprehensive expertise and providing valuable impetus for your innovations. We take a holistic view of the individual motion and control functions here and draw up consistent, end-to-end drive and automation solutions for you - keeping everything as easy as possible and as extensive as necessary.

5

Ensuring productivity

Productivity, reliability and new performance peaks on a daily basis – these are our key success factors for your machine. After delivery, we offer you cleverly devised service concepts to ensure continued safe operation. The primary focus here is on technical support, based on the excellent application expertise of our highly-skilled and knowledgeable after-sales team.

3

Implementing solutions

Our easy formula for satisfied customers is to establish an active partnership with fast decision-making processes and an individually tailored offer. We have been using this simple principle to meet the ever more specialised customer requirements in the field of mechanical engineering for many years.

A matter of principle: the right products for every application.

Lenze's extensive L-force product portfolio follows a very simple principle. The functions of our finely scaled products are assigned to the three lines Base-Line, State-Line or High-Line.

But what does this mean for you? It allows you to quickly recognise which products represent the best solution for your own specific requirements.

Powerful products with a major impact:

- Easy handling
- High quality and durability
- Reliable technologies in tune with the latest developments

Lenze products undergo the most stringent testing in our own laboratory. This allows us to ensure that you will receive consistently high quality and a long service life. In addition to this, five logistics centres ensure that the Lenze products you select are available for quick delivery anywhere across the globe. It's as easy as that!

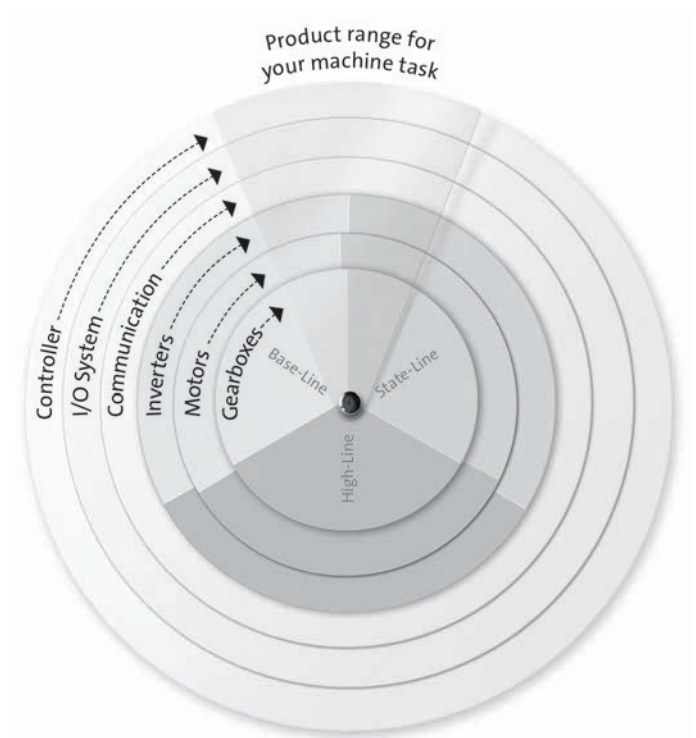

L-force product portfolio

Controls

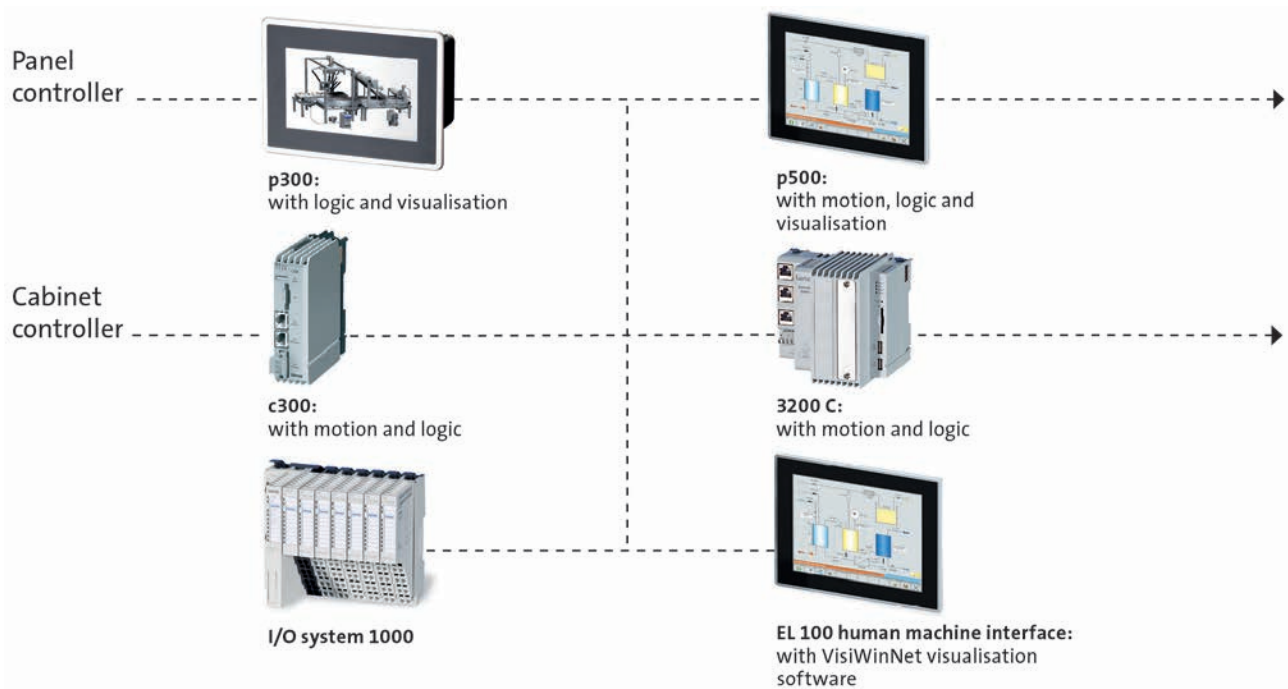

Engineering Tools

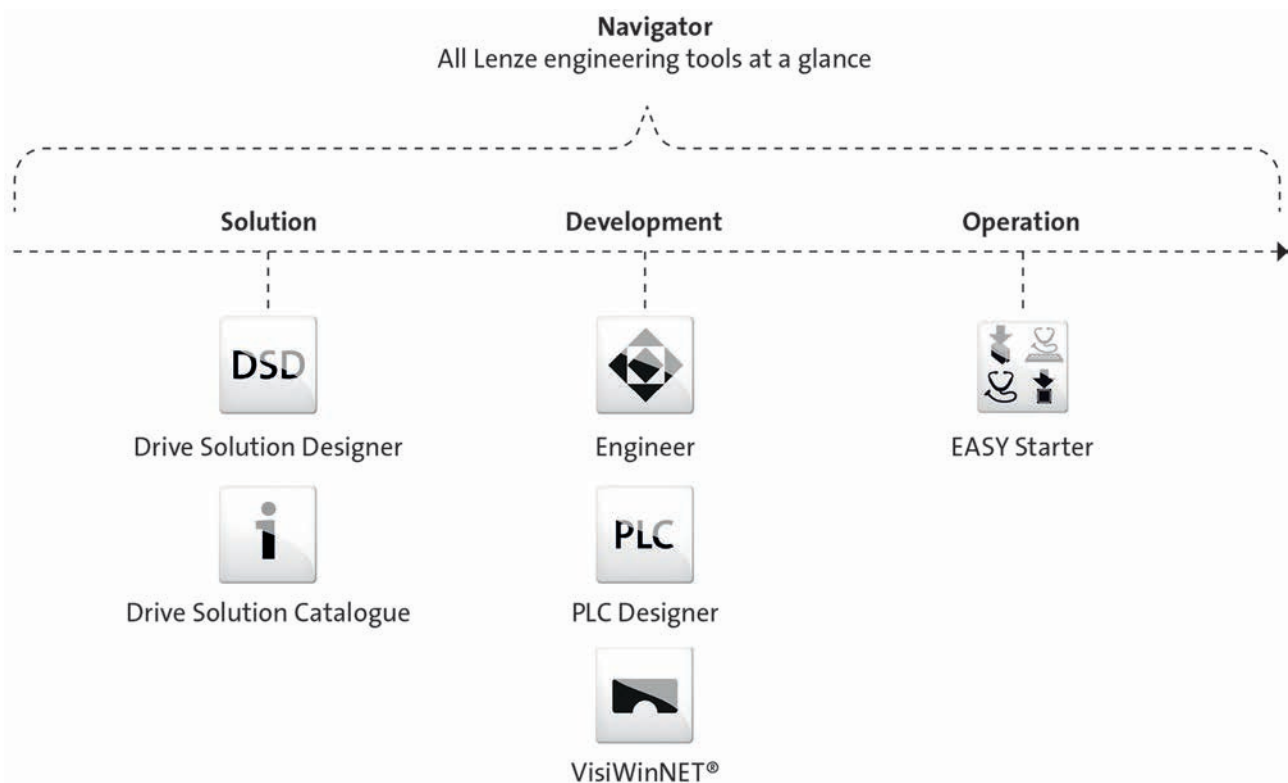

L-force product portfolio

Inverters

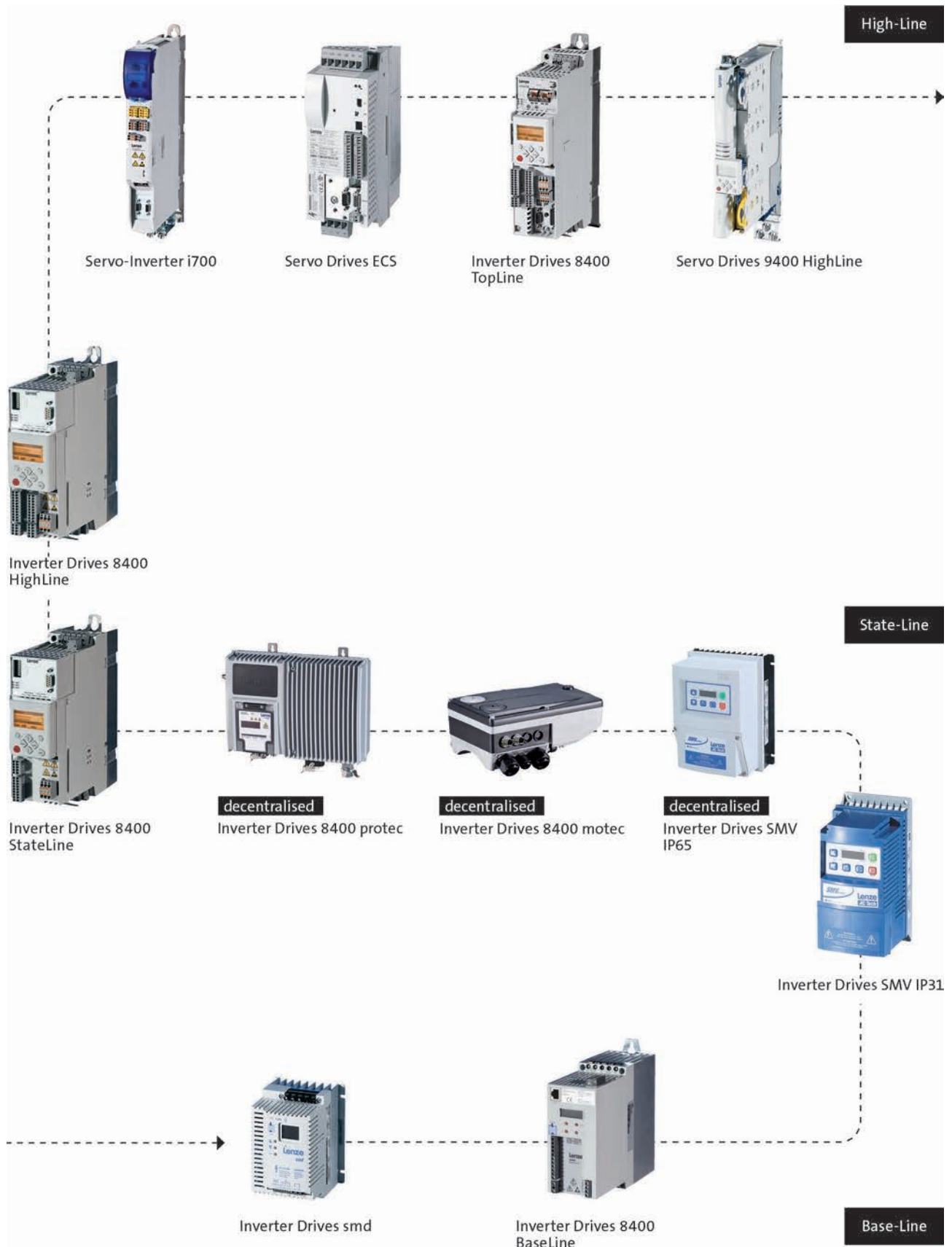

L-force product portfolio

Motors

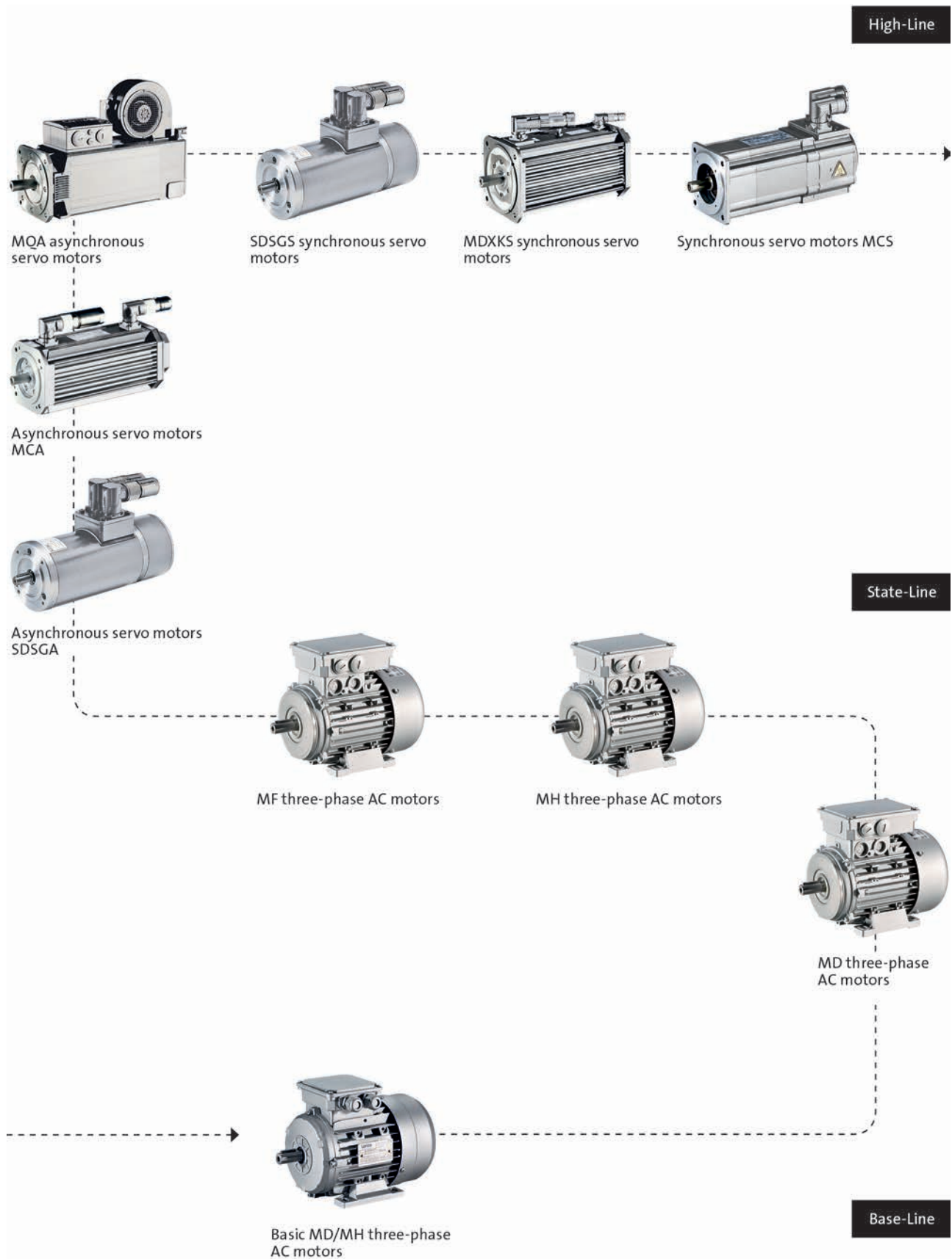

L-force product portfolio

Gearboxes

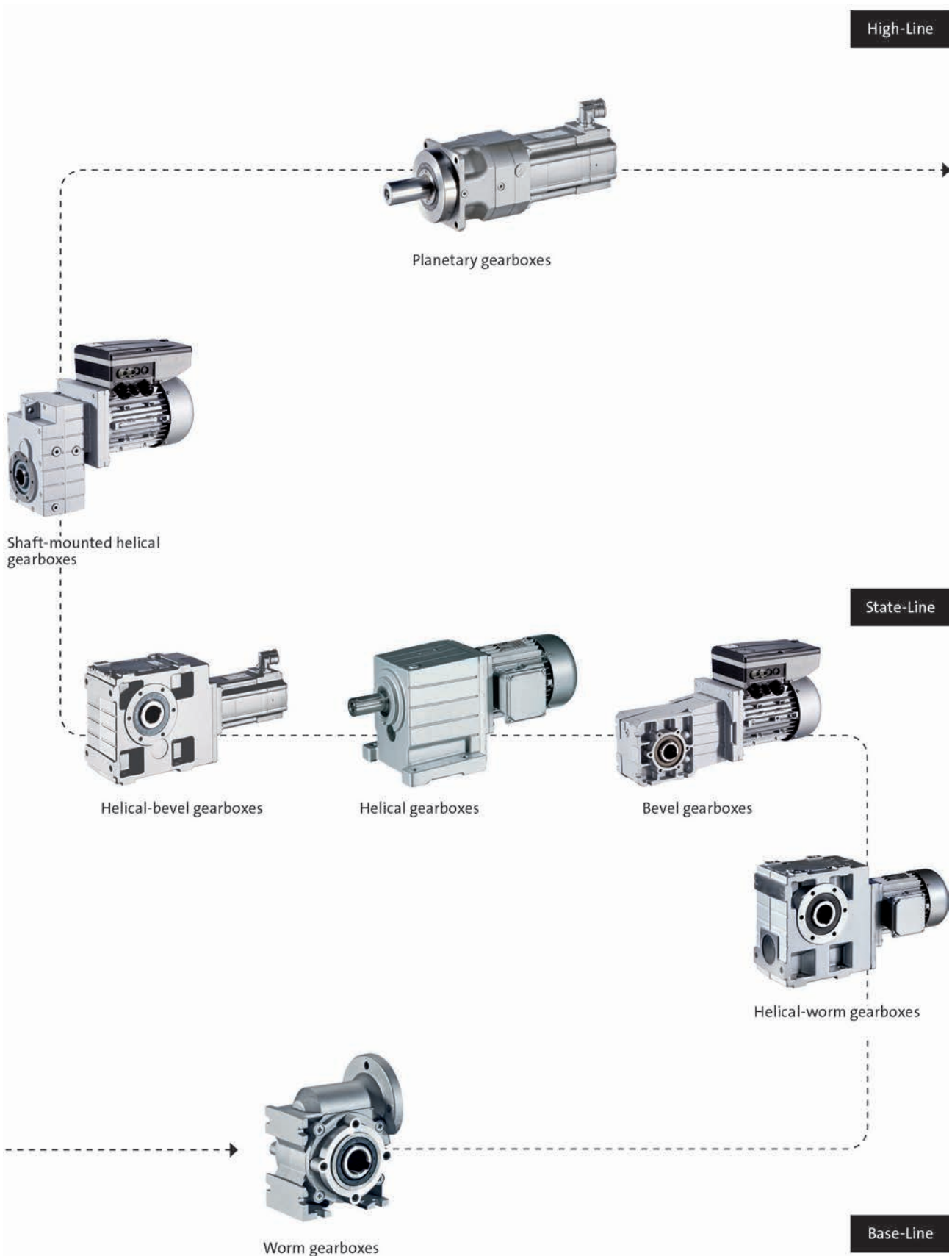

Inverters

Servo Drives 9400 HighLine

0.37 to 370 kW



Servo Drives 9400 HighLine

Contents



General information	Product key	4.4 - 4	
	Product key for power supply modules and regenerative power supply modules	4.4 - 6	
	List of abbreviations	4.4 - 7	
	Servo Drives 9400 Single Drive and Multi Drive	4.4 - 8	
	Functions and features	4.4 - 9	
	Basic dimensioning of axis modules	4.4 - 10	
	Dimensioning for DC-bus operation	4.4 - 11	
Technical data	Standards and operating conditions	4.4 - 13	
	Rated data for Single Drive	4.4 - 14	
	Rated data for Multi Drive	4.4 - 30	
Interfaces	Mains connection	4.4 - 36	
	Motor connection	4.4 - 38	
	Connection diagrams	4.4 - 39	
	Control connections	4.4 - 40	
	Overview of modules	4.4 - 42	
	Memory module	4.4 - 46	
	Safety modules	4.4 - 48	
	Extension module: digital frequency	4.4 - 50	
	Communication module: CANopen	4.4 - 52	
	DeviceNet communication module	4.4 - 54	
	EtherCAT® communication module	4.4 - 56	
	EtherNet/IP communication module	4.4 - 58	
	POWERLINK communication module	4.4 - 60	
	PROFIBUS communication module	4.4 - 62	
	PROFINET communication module	4.4 - 64	
	Accessories	Installation backplane	4.4 - 66
Brake modules		4.4 - 68	
Brake resistors		4.4 - 70	
Mains chokes		4.4 - 72	
RFI and mains filters		4.4 - 74	
Sinusoidal filters		4.4 - 76	
Regenerative power supply modules		Rated data for power supply modules	4.4 - 78
		Rated data for regenerative power supply modules	4.4 - 80
		Control connections	4.4 - 82
		Brake resistors of the regenerative power supply modules	4.4 - 83
		Interference suppression of the regenerative power supply modules	4.4 - 84
		DC input module	4.4 - 86
		DC-bus connection	4.4 - 87
		24 V power supply unit	4.4 - 90
		CAN bus connector	4.4 - 90
		USB diagnostic adapter	4.4 - 91
		X400 keypad	4.4 - 92
		X400 diagnosis terminal	4.4 - 92
		Shield connection kits for motor cable	4.4 - 93
	Other accessories	4.4 - 94	

Servo Drives 9400 HighLine

General information



Product key

E94A S H E 002 4 A 33 EN PM -

Version

S – Single Drive
M – Multi Drive

Series

S – StateLine
H – HighLine

Design

E – Installation

Rated current [A]

(rounded)

002	032	245
003	047	292
004	059	366
007	086	460
009	104	572
013	145	635
017	172	695
024	202	

Voltage class of drive

4 – 3 x 400 V

LF – Digital frequency
CA – CANopen
DN – DeviceNet
ET – EtherCAT
EN – Ethernet
EP – ETHERNET Powerlink MN/CN
EC – ETHERNET Powerlink CN
PM – PROFIBUS
ER – PROFINET
NN – no module

MXI 1

LF
CA
DN
ET
EN
EP
EC
PM
ER
NN

MXI 2

LF
CA
DN
ET
EN
EP
EC
PM
ER
NN

MMI

11 – MM110
22 – MM220
33 – MM330
43 – MM430

MSI

A – SM0
B – SM100
D – SM300
E – SM301

MXI 1 – Slot for extension module 1

MXI 2 – Slot for extension module 2

MMI – Slot for memory module

MSI – Slot for safety module

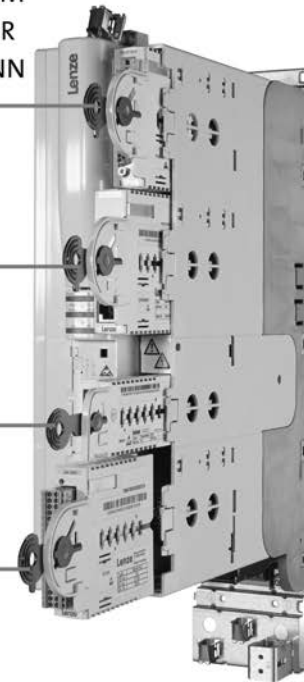

Servo Drives 9400 HighLine

General information

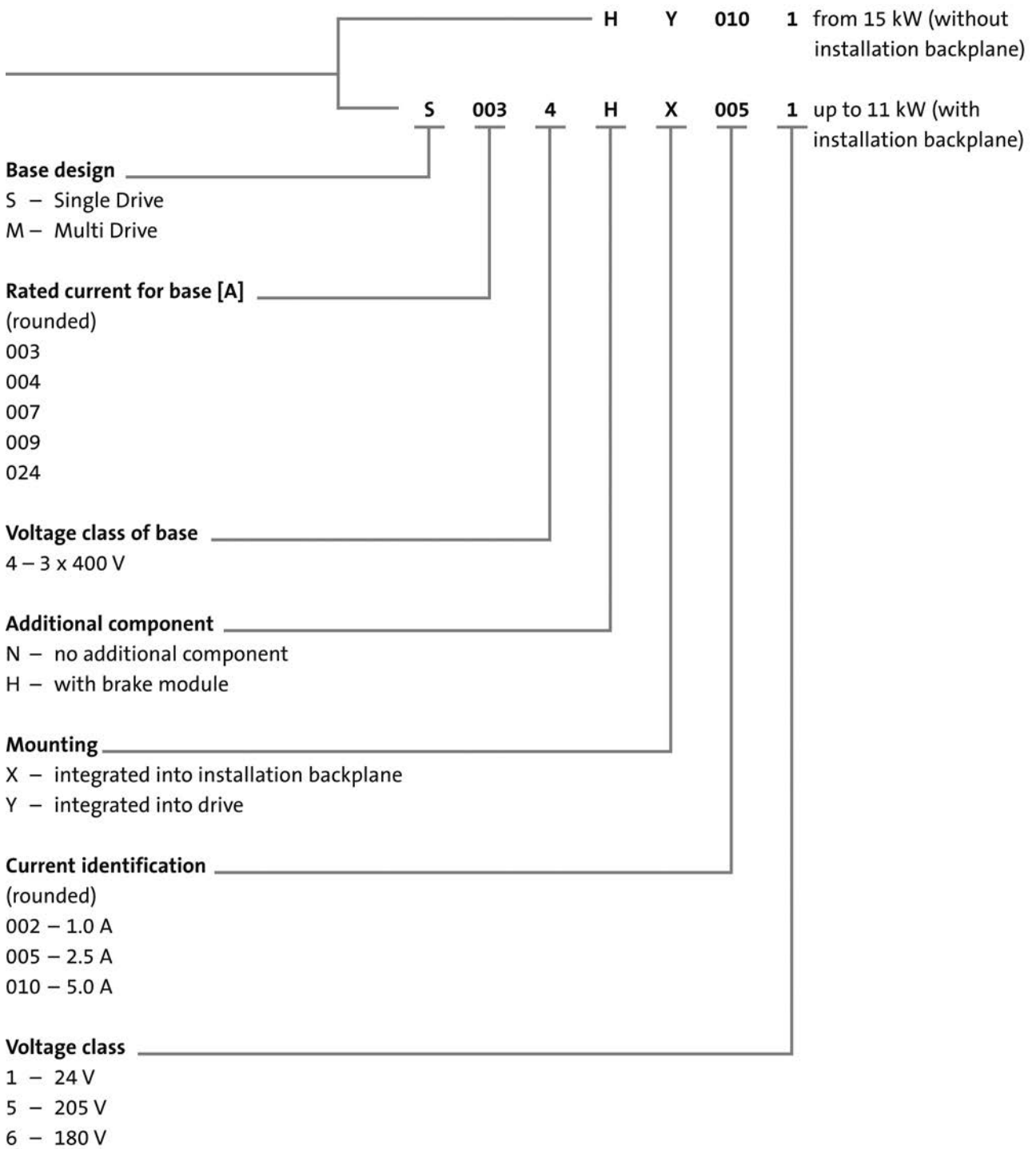

Servo Drives 9400 HighLine

General information



Product key for power supply modules and regenerative power supply modules

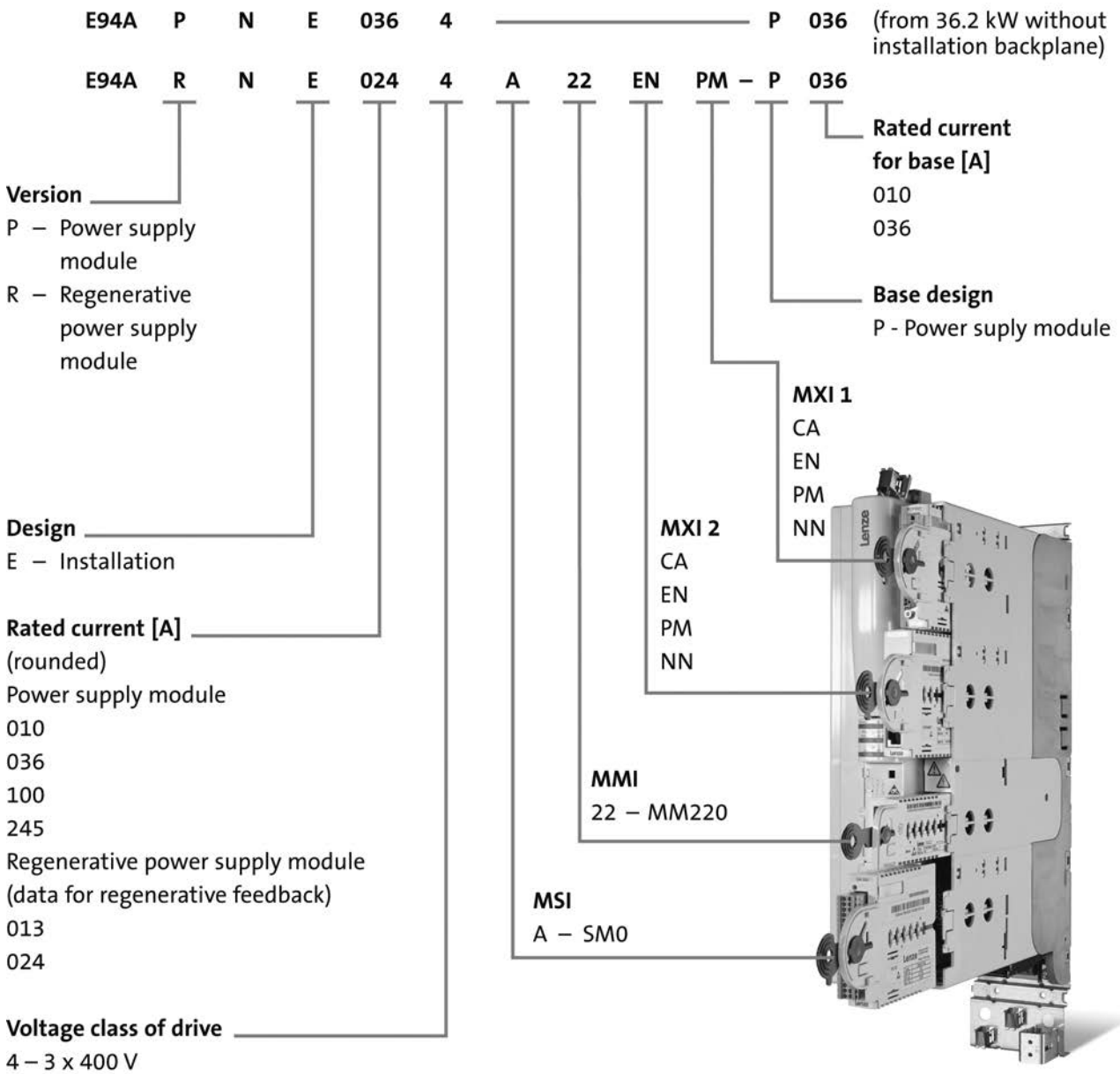

4.4

CA – CANopen
EN – Ethernet
PM – PROFIBUS
NN – no module

MXI 1 – Slot for extension module 1
MXI 2 – Slot for extension module 2
MMI – Slot for memory module
MSI – Slot for safety module

Servo Drives 9400 HighLine

General information



List of abbreviations

b	[mm]	Dimensions
C _{th}	[KW]	Thermal capacity
f _{ch}	[kHz]	Rated switching frequency
h	[mm]	Dimensions
i		Ratio
I _{N, out}	[A]	Rated output current
I _{N, AC}	[A]	Rated mains current
I _{N, DC}	[A]	Rated DC-bus current
I _{red, out}	[A]	Reduced output current
I _{red, DC}	[A]	Reduced DC-bus current
m	[kg]	Mass
n _{max}	[r/min]	Max. speed
P	[kW]	Typical motor power
P _N	[kW]	Rated power
P _{max, 1}	[kW]	Max. output power
P _{max, 2}	[kW]	Max. short-time output power
P _V	[kW]	Power loss
R _N	[Ω]	Rated resistance
R _{min}	[Ω]	Min. brake resistance
t	[mm]	Dimensions
U	[V]	Voltage drop
U _{AC}	[V]	Mains voltage
U _{DC}	[V]	DC supply
U _{N, AC}	[V]	Rated voltage
U _{N, DC}	[V]	Rated voltage
U _{out}	[V]	Output voltage

DIAG	Slot for diagnostic adapter
DIN	Deutsches Institut für Normung e.V.
EN	European standard
EN 60529	Degrees of protection provided by enclosures (IP code)
EN 60721-3	Classification of environmental conditions; Part 3: Classes of environmental parameters and their limit values
EN 61800-3	Electrical variable speed drives Part 3: EMC requirements including special test methods
IEC 61131-2	Programmable logic controllers Part 2: Equipment and tests
IEC	International Electrotechnical Commission
IEC 61508	Functional safety of electrical/electronic/programmable electronic safety-related systems
IM	International Mounting Code
IP	International Protection Code
MMI	Modular memory interface (memory module)
MSI	Modular safety interface (safety module)
NEMA	National Electrical Manufacturers Association
UL	Underwriters Laboratory Listed Product
UR	Underwriters Laboratory Recognized Product
VDE	Verband deutscher Elektrotechniker (Association of German Electrical Engineers)

Servo Drives 9400 HighLine

General information



Servo Drives 9400 Single Drive and Multi Drive

Many technical advances make our day-to-day life easier. A simply click is all that is needed and

- the lights come on
- a safety belt is engaged
- you can surf the Internet
- you can take a snapshot of your family.

The Servo Drives 9400 will revolutionise your servo technology – with simple clicks.

Single drive

Our single-axis devices combine mains supply, DC bus and inverter in a single unit. The filter elements and the brake chopper are integrated in the servo inverter and allow autonomous use in distributed control cabinet installations. By using corresponding footprint filters (up to 55 kW), greater interference suppression can be achieved without additional mounting area.

Multi Drive

Our multi-axis drives are particularly suitable for centralised, compact multi-axis installations. The energy exchange via the DC bus reduces the power requirement on the mains side. The axes share the same mains supply, brake chopper and EMC filter. The parts requirements and installation work are thus significantly reduced. The integrated DC busbar system provides for compact installations for drives rated up to 15 kW.

HighLine - for decentralised control concepts

The Servo Drives 9400 HighLine feature intelligence in the drive and are therefore designed for decentralised motion control applications as well as for centralised control topologies.

Lenze provides pre-programmed technology applications, e.g. table positioning, electronic gearbox and synchronism with mark registration for solving various applications simply by parameter setting. The function block editor integrated into the L-force Engineer HighLevel (PC setup tool) enables you to adapt the functions in an easy and flexible manner.

The HighLine Servo Drive comes with the CANopen fieldbus, conventional I/Os, diagnostic LEDs, a diagnostic interface, a resolver and a universal encoder input on board.

In addition, the HighLine is equipped with two extension slots for communication or extension modules as well as one slot each for a memory module and a safety module, so that the drive can be optimally adapted to your requirements.

4.4

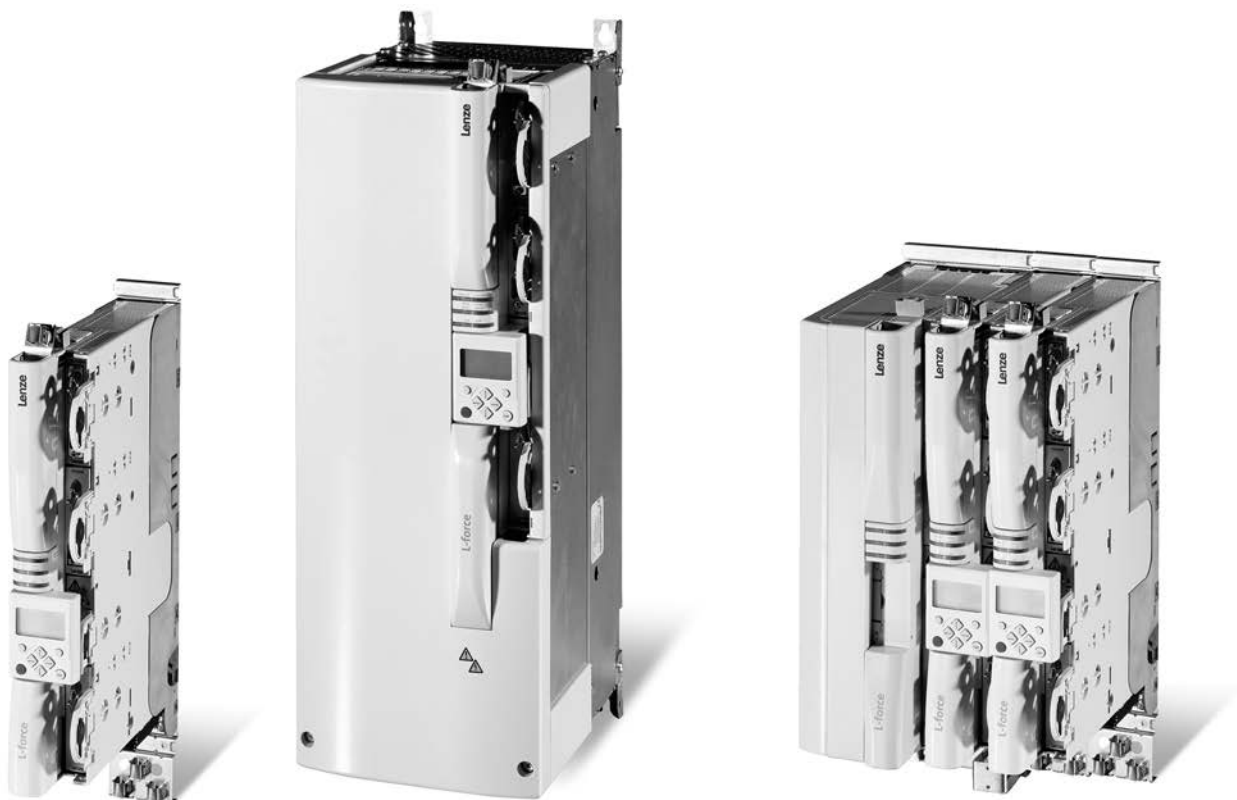

Servo Drives 9400 Single Drive and Servo Drives 9400 Multi Drive

Servo Drives 9400 HighLine

General information



Functions and features

Mode	Servo Drives 9400 HighLine
Control types, motor control	
Field-oriented servo control (SC)	For synchronous servo motors, asynchronous servo motors and three-phase asynchronous motors
Sensorless control (SLPSM)	For synchronous servo motors
V/f control (VFCplus)	For three-phase AC motors and asynchronous servo motor (linear or square-law)
Basic functions	<ul style="list-style-type: none"> Freely assignable user menu Free function block interconnection with extensive function library Parameter change-over DC brake function Brake management for brake control with low rate of wear Flying restart circuit S-shaped ramps for smooth acceleration PID controller
Operating modes to CiA 402	<ul style="list-style-type: none"> - Homing mode Interpolated position mode Cyclic synchronous position (csp) - cyclic position setpoint Cyclic synchronous velocity (csv) - cyclic velocity setpoint Cyclic synchronous torque (cst) - cyclic torque setpoint
Evaluation of ENP (ETS)	For Lenze servo motors
Technology applications	<ul style="list-style-type: none"> Speed actuating drive Torque actuating drive Electronic gearbox Synchronism with mark registration Table positioning Positioning sequence control
Advanced functions	Function blocks for cam function
Monitoring and protective measures	<ul style="list-style-type: none"> Short circuit Earth fault Overvoltage Undervoltage Motor phase failure Overcurrent I² x t-Motor monitoring Overtemperature Motor overtemperature Brake chopper, brake resistance Fan Motor stalling
Diagnostics	Data logger, logbook, oscilloscope functions
Status display	6 LEDs
Diagnostic interface	Integrated For USB diagnostic adapter or keypad (diagnosis terminal)
Braking operation	
Brake chopper	Integrated in Single Drives
Brake resistor	External



Basic dimensioning of axis modules

The most important steps for dimensioning Single Drive and Multi Drive axis modules are listed here:

- Motor power required**
 First, the maximum torque required M_{max} , the maximum speed n_{max} , the effective torque M_{eff} and - for geared motors - the transmission ratio i are determined from the system data.
- Motor selection**
 Based on these values, the appropriate servo motor can be selected from the MCS (synchronous motors), MCA, MQA or MDFQA (asynchronous motors) ranges.

- Selecting the axis module**

The axis modules are selected on the basis of the maximum currents and power required. Depending on the drive, the 9400 Servo Drives and the power supply modules can be operated for overload time t_{ol} with maximum output current I_{max} , provided that the drive is then operated for recovery time t_{re} with a reduced output current. The switching frequency is automatically adapted to the rate of utilisation.

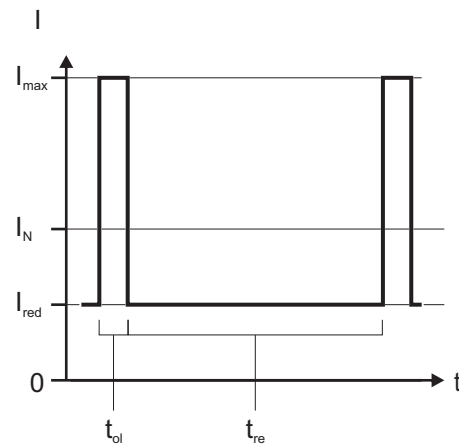

Maximum output current cycle

- Braking operation**

If high moments of inertia are to be braked or if extended operation in generator mode is to be executed, braking energy can be transferred to an external brake resistor or converted into heat with Single Drive axis modules or with power supply modules via the integrated brake chopper.

The brake chopper can dissipate the continuous braking power P_N on a continual basis (case A) or the peak braking power P_{max} for the running time t_{on} followed by the recovery time t_{re} (case B).

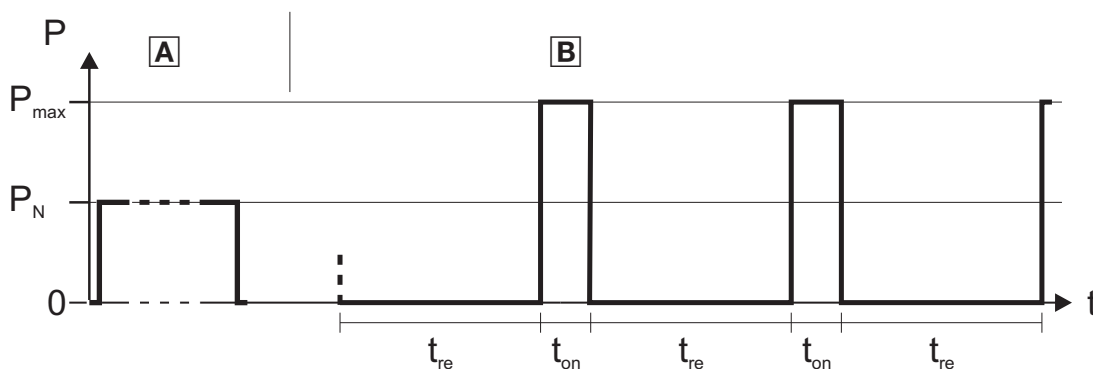

Brake chopper output power

Servo Drives 9400 HighLine

General information



Dimensioning for DC-bus operation

Dimensioning of DC-bus operation for axis modules

The most effective way of determining the correct power supply module for a multi-axis application is if the time/power diagrams for the complete machine cycle are available for all axis modules. Adding together the simultaneous individual power levels gives the required overall power and thereby the minimum power of the power supply module. The necessary braking power or regenerative power can be determined in the same way.

- The axis modules in the network can be easily dimensioned using the DSC. Including energy analysis and Energy Performance Certificate.

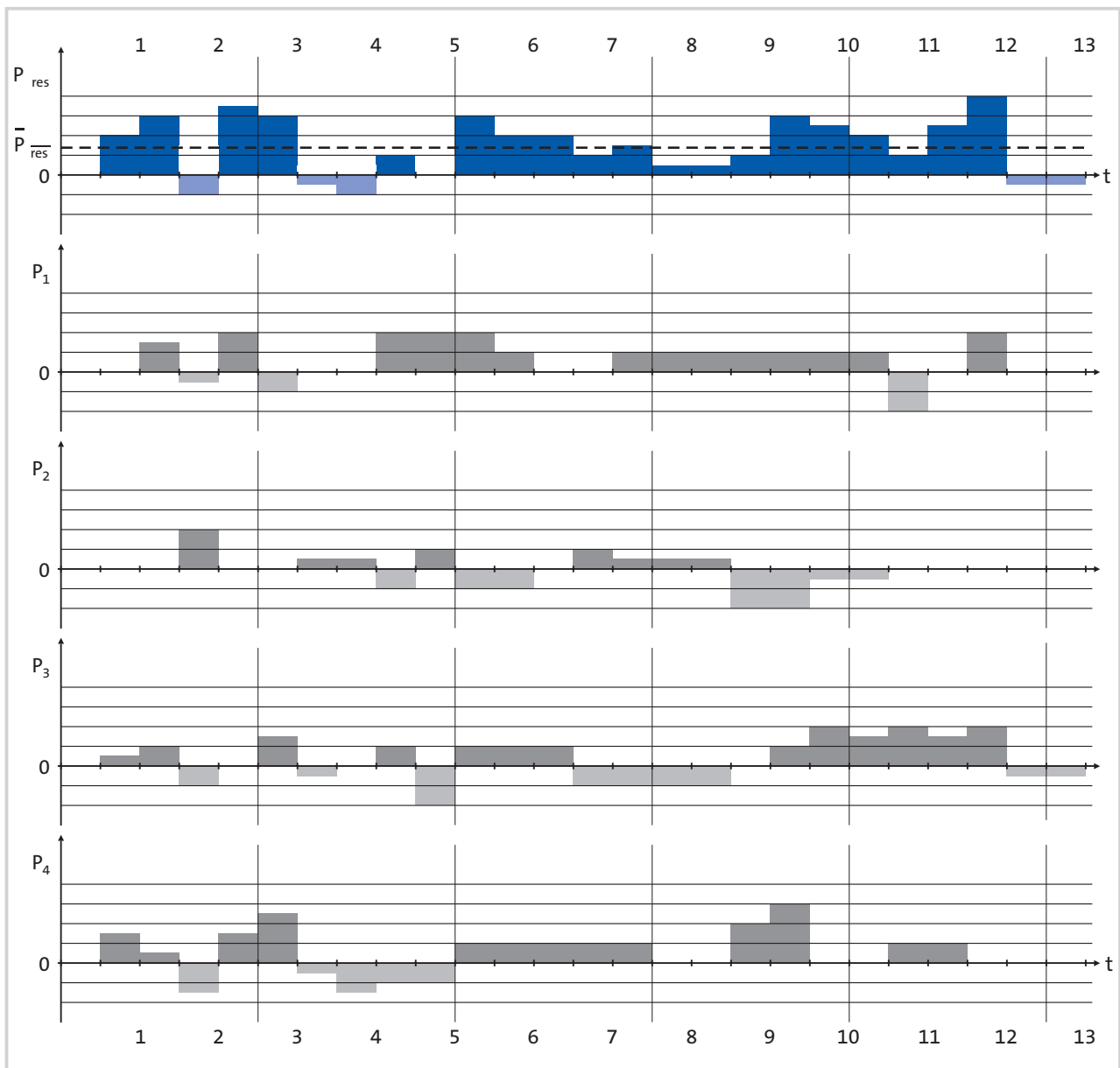

Time/power diagram of a multi-axis servo system

$P_1 \dots P_4$ = individual power of axis 1...axis 4

P_{res} = addition of individual powers

$P_{res 1-4}$ = mean value of individual powers

Servo Drives 9400 HighLine

General information



Servo Drives 9400 HighLine

Technical data



Standards and operating conditions

Conformity			
CE			Low-Voltage Directive 2006/95/EC
EAC			TP TC 004/2011 (TR C) TP TC 020/2011 (TR C)
Approval			
UL 508C			Power Conversion Equipment (file no. E132659) ¹⁾
Enclosure			
EN 60529			IP20 ²⁾
NEMA 250			Type 1
Climatic conditions			
Storage (EN 60721-3-1)			1K3 (temperature: -25 °C ... +60 °C)
Transport (EN 60721-3-2)			2K3 (temperature: -25 °C ... +70 °C)
Operation (EN 60721-3-3)			3K3 (temperature: -10°C ... +55°C)
Site altitude			
Amsl	H _{max}	[m]	4000
Vibration resistance			
Transport (EN 60721-3-2)			2M2
Operation (Germanischer Lloyd)			5 Hz ≤ f ≤ 13.2 Hz: ± 1 mm amplitude 13.2 Hz ≤ f ≤ 100 Hz: 0.7 g

¹⁾ In preparation for the products: sinusoidal filters EZS3-180A200 to EZS3-480A200 and mains filters for regenerative power supply modules.

²⁾ Not in the wire range of the on the motor-side terminals

Supply form			
			Systems with earthed star point (TN and TT systems) Systems with high-resistance or isolated star point (IT systems)
Discharge current to PE			
EN 61800-5-1	I	[mA]	> 3.5 mA, fixed installation required, PE must be reinforced
Noise emission			
EN 61800-3			Cable-guided disturbance: Max. shielded motor cable lengths for compliance with EMC protection requirement C2 without external filters E94AS□E0024 to E94AS□E0244: 10 m E94AS□E0324 to E94AS□E1044: 50 m E94AS□E1454 to E94AS□E6954: 150 m
Noise immunity			
EN 61800-3			Category C3
Insulation resistance			
EN 61800-5-1			Overvoltage category III Above 2000 m amsl overvoltage category II
Degree of pollution			
EN 61800-5-1			2
Protective insulation of control circuits			
EN 61800-5-1			for digital inputs and outputs Safe mains isolation: double/reinforced insulation

4.4

Servo Drives 9400 HighLine





Technical data



Rated data for Single Drive

- ▶ The data is valid for operation at 3/PE AC 400 V or DC 565 V.
- ▶ Unless otherwise specified, the data refers to the default setting.

- ▶ Rated data for operation at 3/PE/AC 500 V
DS_9400_0001
Available for download at www.lenze.de/dsc

						
Typical motor power						
4-pole asynchronous motor	P	[kW]	0.37	0.75	1.50	3.00
Product key²⁾						
Single Drive			E94AS□E0024	E94AS□E0034	E94AS□E0044	E94AS□E0074
Mains voltage range			3/PE AC 180 V-0 % ... 550 V+0 %, 45 Hz-0 % ... 65 Hz+0 %			
	U _{AC}	[V]				
Rated mains current						
With mains choke	I _{N, AC}	[A]	1.5	2.5	3.9	7.0
Without mains choke	I _{N, AC}	[A]	2.1	3.5	5.5	9.9
Rated output current						
	I _{N, out}	[A]	1.5	2.5	4.0	7.0
Rated switching frequency			8			
	f _{ch}	[kHz]				
Output current						
2 kHz	I _{out}	[A]	1.9 ³⁾	3.1 ³⁾	5.0 ³⁾	8.8 ³⁾
4 kHz	I _{out}	[A]	1.9 ³⁾	3.1 ³⁾	5.0 ³⁾	8.8 ³⁾
8 kHz	I _{out}	[A]	1.5	2.5	4.0	7.0
16 kHz	I _{out}	[A]	1.1	1.9	3.0	5.3

Data for 60 s overload

Max. output current^{1, 4)}						
	I _{max, out}	[A]	2.8	4.7	7.5	13.1
Reduced output current^{1, 4)}						
	I _{red, out}	[A]	1.40	2.30	3.80	6.60
Overload time^{1, 4)}			60.0			
	t _{ol}	[s]				
Recovery time^{1, 4)}			120.0			
	t _{re}	[s]				

Data for 0.5 s overload

Max. short-time output current^{1, 4)}						
	I _{max, out}	[A]	6.0	10.0	16.0	21.0
Reduced output current^{1, 4)}						
	I _{red, out}	[A]	1.40	2.30	3.80	6.60
Overload time^{1, 4)}			0.5			
	t _{ol}	[s]				
Recovery time^{1, 4)}			4.5			
	t _{re}	[s]				

²⁾  1 - Please refer to the Product key section

¹⁾  10 - See diagram

³⁾ Operation only permitted with mains choke or mains filter

⁴⁾ Mains filter necessary. Without a mains filter, the indicated values for I_{max} and I_{red} decrease

Servo Drives 9400 HighLine



Technical data



Rated data for Single Drive

- ▶ The data is valid for operation at 3/PE AC 400 V or DC 565 V.
- ▶ Unless otherwise specified, the data refers to the default setting.

- ▶ Rated data for operation at 3/PE/AC 500 V
DS_9400_0001
Available for download at www.lenze.de/dsc

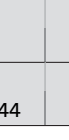
						
Typical motor power						
4-pole asynchronous motor	P	[kW]	0.37	0.75	1.50	3.00
Product key²⁾						
Single Drive			E94AS□E0024	E94AS□E0034	E94AS□E0044	E94AS□E0074
DC supply			DC 260 V -0 % ... 775 V +0 %			
	U _{DC}	[V]	DC 260 V -0 % ... 775 V +0 %			
Rated DC-bus current						
	I _{N,DC}	[A]	2.6	4.3	6.7	12.1
Power loss						
	P _V	[W]	110	130	160	210
Dimensions						
Height	h	[mm]	350			
Height, including fastening	h	[mm]	481			
Width	b	[mm]	60			90
Depth	t	[mm]	288			
Mass						
	m	[kg]	4.0			5.3
Max. cable length						
shielded C1 with external measures	l _{max}	[m]	25			
shielded C2 without external measures	l _{max}	[m]	10			
shielded C2 with external measures	l _{max}	[m]	50			100

4.4

Brake chopper rated data

Rated power, Brake chopper¹⁾					
	P _N	[kW]	1.3	1.9	2.6
Max. output power, Brake chopper¹⁾					
	P _{max,1}	[kW]	6.4	11.2	
Running time¹⁾					
	t _{on}	[s]	1.0		
Recovery time¹⁾					
	t _{re}	[s]	4.3	4.4	4.2
Min. brake resistance¹⁾					
	R _{min}	[Ω]	82.0	47.0	

²⁾  1 - Please refer to the Product key section

¹⁾  10 - See diagram

Servo Drives 9400 HighLine

Technical data



Rated data for Single Drive

- ▶ The data is valid for operation at 3/PE AC 400 V or DC 565 V.
- ▶ Unless otherwise specified, the data refers to the default setting.

- ▶ Rated data for operation at 3/PE/AC 500 V
DS_9400_0001
Available for download at www.lenze.de/dsc

					
Typical motor power					
4-pole asynchronous motor	P	[kW]	5.50	7.50	11.0
Product key¹⁾					
Single Drive			E94AS□E0134	E94AS□E0174	E94AS□E0244
Mains voltage range					
	U _{AC}	[V]	3/PE AC 180 V-0 % ... 550 V+0 %, 45 Hz-0 % ... 65 Hz+0 %		
Rated mains current					
With mains choke	I _{N, AC}	[A]	11.8	15.0	20.5
Without mains choke	I _{N, AC}	[A]	16.8	21.0	29.0
Rated output current					
	I _{N, out}	[A]	13.0	16.5	23.5
Rated switching frequency					
	f _{ch}	[kHz]	8		
Output current					
2 kHz	I _{out}	[A]	16.3 ³⁾	20.6 ³⁾	29.4 ³⁾
4 kHz	I _{out}	[A]	16.3 ³⁾	20.6 ³⁾	29.4 ³⁾
8 kHz	I _{out}	[A]	13.0	16.5	23.5
16 kHz	I _{out}	[A]	9.8	12.4	17.6

Data for 60 s overload

Max. output current^{2, 4)}					
	I _{max, out}	[A]	24.4	30.9	44.1
Reduced output current^{2, 4)}					
	I _{red, out}	[A]	12.2	15.5	22.1
Overload time^{2, 4)}					
	t _{ol}	[s]	60.0		
Recovery time^{2, 4)}					
	t _{re}	[s]	120.0		

Data for 0.5 s overload

Max. short-time output current^{2, 4)}					
	I _{max, out}	[A]	39.0	49.5	58.8
Reduced output current^{2, 4)}					
	I _{red, out}	[A]	12.2	15.5	22.1
Overload time^{2, 4)}					
	t _{ol}	[s]	0.5		
Recovery time^{2, 4)}					
	t _{re}	[s]	4.5		

¹⁾  1 - Please refer to the Product key section

²⁾  10 - See diagram

³⁾ Operation only permitted with mains choke or mains filter

⁴⁾ Mains filter necessary. Without a mains filter, the indicated values for I_{max} and I_{red} decrease

Servo Drives 9400 HighLine

Technical data



Rated data for Single Drive

- ▶ The data is valid for operation at 3/PE AC 400 V or DC 565 V.
- ▶ Unless otherwise specified, the data refers to the default setting.

- ▶ Rated data for operation at 3/PE/AC 500 V
DS_9400_0001
Available for download at www.lenze.de/dsc

					
Typical motor power					
4-pole asynchronous motor	P	[kW]	5.50	7.50	11.0
Product key ²⁾					
Single Drive			E94AS□E0134	E94AS□E0174	E94AS□E0244
DC supply					
	U _{DC}	[V]	DC 260 V -0 % ... 775 V +0 %		
Rated DC-bus current					
	I _{N,DC}	[A]	20.6	25.7	35.5
Power loss					
	P _V	[W]	320	380	500
Dimensions					
Height	h	[mm]	350		
Height, including fastening	h	[mm]	481		
Width	b	[mm]	120		
Depth	t	[mm]	288		
Mass					
	m	[kg]	8.1		
Max. cable length					
shielded C1 with external measures	I _{max}	[m]	25		
shielded C2 without external measures	I _{max}	[m]	10		
shielded C2 with external measures	I _{max}	[m]	100		

4.4

Brake chopper rated data

Rated power, Brake chopper ¹⁾					
	P _N	[kW]	4.7	6.4	9.3
Max. output power, Brake chopper ¹⁾					
	P _{max,1}	[kW]	19.5	29.2	
Running time ¹⁾					
	t _{on}	[s]	1.0		
Recovery time ¹⁾					
	t _{re}	[s]	4.2	4.3	3.9
Min. brake resistance ¹⁾					
	R _{min}	[Ω]	27.0	18.0	

²⁾  1 - Please refer to the Product key section

¹⁾  10 - See diagram

Servo Drives 9400 HighLine

Technical data



Rated data for Single Drive

- ▶ The data is valid for operation at 3/PE AC 400 V or DC 565 V.
- ▶ Unless otherwise specified, the data refers to the default setting.

- ▶ Rated data for operation at 3/PE/AC 500 V
DS_9400_0001
Available for download at www.lenze.de/dsc

					
Typical motor power					
4-pole asynchronous motor	P	[kW]	15.0	22.0	30.0
Product key ¹⁾					
Single Drive			E94AS□E0324	E94AS□E0474	E94AS□E0594
Mains voltage range					
	U _{AC}	[V]	3/PE AC 180 V-0 % ... 550 V+0 %, 45 Hz-0 % ... 65 Hz+0 %		
Rated mains current					
With mains choke	I _{N, AC}	[A]	29.0	43.0	54.0
Without mains choke	I _{N, AC}	[A]	29.0	43.0	54.0
Rated output current					
	I _{N, out}	[A]	32.0	47.0	59.0
Rated switching frequency					
	f _{ch}	[kHz]	8	4	
Output current					
2 kHz	I _{out}	[A]	38.4	47.0	59.0
4 kHz	I _{out}	[A]	38.4	47.0	59.0
8 kHz	I _{out}	[A]	32.0	41.0	
16 kHz	I _{out}	[A]	16.8	21.5	

Data for 60 s overload

Max. output current ²⁾					
	I _{max, out}	[A]	57.6	70.5	88.5
Reduced output current ²⁾					
	I _{red, out}	[A]	28.8	35.3	44.3
Overload time ²⁾					
	t _{ol}	[s]	60.0		
Recovery time ²⁾					
	t _{re}	[s]	120.0		

Data for 0.5 s overload

Max. short-time output current ²⁾					
	I _{max, out}	[A]	76.8	94.0	118.0
Reduced output current ²⁾					
	I _{red, out}	[A]	28.8	35.3	44.3
Overload time ²⁾					
	t _{ol}	[s]	0.5		
Recovery time ²⁾					
	t _{re}	[s]	4.5		

¹⁾  1 - Please refer to the Product key section

²⁾  10 - See diagram

Servo Drives 9400 HighLine

Technical data



Rated data for Single Drive

- ▶ The data is valid for operation at 3/PE AC 400 V or DC 565 V.
- ▶ Unless otherwise specified, the data refers to the default setting.

- ▶ Rated data for operation at 3/PE/AC 500 V
DS_9400_0001
Available for download at www.lenze.de/dsc

					
Typical motor power					
4-pole asynchronous motor	P	[kW]	15.0	22.0	30.0
Product key ²⁾					
Single Drive			E94AS□E0324	E94AS□E0474	E94AS□E0594
DC supply					
	U _{DC}	[V]	DC 260 V -0 % ... 775 V +0 %		
Rated DC-bus current					
	I _{N,DC}	[A]	36.0	53.0	66.0
Power loss					
	P _V	[W]	700	1050	1122
Dimensions					
Height	h	[mm]	556		
Height, including fastening	h	[mm]	606		
Width	b	[mm]	206		
Depth	t	[mm]	294		
Mass					
	m	[kg]	26.5		
Max. cable length					
shielded C1 with external measures	l _{max}	[m]	50		
shielded C2 without external measures	l _{max}	[m]	50		
shielded C2 with external measures	l _{max}	[m]	100		

4.4

Brake chopper rated data

Rated power, Brake chopper ¹⁾					
	P _N	[kW]	12.6	18.6	25.3
Max. output power, Brake chopper ¹⁾					
	P _{max,1}	[kW]	29.2	35.0	
Running time ¹⁾					
	t _{on}	[s]	260.0	320.0	430.0
Recovery time ¹⁾					
	t _{re}	[s]	340.0	280.0	170.0
Min. brake resistance ¹⁾					
	R _{min}	[Ω]	18.0	15.0	

²⁾  1 - Please refer to the Product key section

¹⁾  10 - See diagram

Servo Drives 9400 HighLine

Technical data



Rated data for Single Drive

- ▶ The data is valid for operation at 3/PE AC 400 V or DC 565 V.
- ▶ Unless otherwise specified, the data refers to the default setting.

- ▶ Rated data for operation at 3/PE/AC 500 V
DS_9400_0001
Available for download at www.lenze.de/dsc

					
Typical motor power					
4-pole asynchronous motor	P	[kW]	45.0	55.0	
Product key ¹⁾					
Single Drive			E94AS□E0864	E94AS□E1044	
Mains voltage range					
	U _{AC}	[V]	3/PE AC 180 V-0 % ... 550 V+0 %, 45 Hz-0 % ... 65 Hz+0 %		
Rated mains current					
With mains choke	I _{N, AC}	[A]	79.0	95.0	
Without mains choke	I _{N, AC}	[A]	79.0	95.0	
Rated output current					
	I _{N, out}	[A]	86.0	104.0	
Rated switching frequency					
	f _{ch}	[kHz]	4		
Output current					
2 kHz	I _{out}	[A]	86.0	104.0	
4 kHz	I _{out}	[A]	86.0	104.0	
8 kHz	I _{out}	[A]	73.0	78.0	
16 kHz	I _{out}	[A]	38.3	41.0	

4.4

Data for 60 s overload

Max. output current ²⁾				
	I _{max, out}	[A]	129.0	156.0
Reduced output current ²⁾				
	I _{red, out}	[A]	64.5	78.0
Overload time ²⁾				
	t _{ol}	[s]	60.0	
Recovery time ²⁾				
	t _{re}	[s]	120.0	

Data for 0.5 s overload

Max. short-time output current ²⁾				
	I _{max, out}	[A]	172.0	208.0
Reduced output current ²⁾				
	I _{red, out}	[A]	64.5	78.0
Overload time ²⁾				
	t _{ol}	[s]	0.5	
Recovery time ²⁾				
	t _{re}	[s]	4.5	

¹⁾  1 - Please refer to the Product key section

²⁾  10 - See diagram

Servo Drives 9400 HighLine

Technical data



Rated data for Single Drive

- ▶ The data is valid for operation at 3/PE AC 400 V or DC 565 V.
- ▶ Unless otherwise specified, the data refers to the default setting.

- ▶ Rated data for operation at 3/PE/AC 500 V
DS_9400_0001
Available for download at www.lenze.de/dsc

				
Typical motor power				
4-pole asynchronous motor	P	[kW]	45.0	55.0
Product key ²⁾				
Single Drive			E94AS□E0864	E94AS□E1044
Rated DC-bus current				
	$I_{N,DC}$	[A]	96.8	116.4
Power loss				
	P_V	[W]	1500	1800
Dimensions				
Height	h	[mm]	655	
Height, including fastening	h	[mm]	706	
Width	b	[mm]	266	
Depth	t	[mm]	370	
Mass				
	m	[kg]	42.0	
Max. cable length				
shielded C2 without external measures	l_{max}	[m]	50	
shielded C2 with external measures	l_{max}	[m]	100	

4.4

Brake chopper rated data

Rated power, Brake chopper ¹⁾				
	P_N	[kW]	37.9	46.3
Max. output power, Brake chopper ¹⁾				
	$P_{max,1}$	[kW]	70.1	
Running time ¹⁾				
	t_{on}	[s]	320.0	400.0
Recovery time ¹⁾				
	t_{re}	[s]	280.0	200.0
Min. brake resistance ¹⁾				
	R_{min}	[Ω]	7.5	

²⁾  1 - Please refer to the Product key section

¹⁾  10 - See diagram

Servo Drives 9400 HighLine

Technical data



Rated data for Single Drive

- ▶ The data is valid for operation at 3/PE AC 400 V or DC 565 V.
- ▶ Unless otherwise specified, the data refers to the default setting.

- ▶ Rated data for operation at 3/PE/AC 500 V
DS_9400_0001
Available for download at www.lenze.de/dsc

Typical motor power											
4-pole asynchronous motor	P	[kW]	75.0	85.0 ³⁾	95.0 ⁴⁾	90.0	105 ³⁾	110 ⁴⁾	105	125 ³⁾	135 ⁴⁾
Product key¹⁾			E94AS□E1454			E94AS□E1724			E94AS□E2024		
Mains voltage range			3/PE AC 342 V-0 % ... 550 V+0 %, 48 Hz-0 % ... 65 Hz+0 %								
Rated mains current											
With mains choke	$I_{N, AC}$	[A]	140.0			166.0			195.0		
Without mains choke	$I_{N, AC}$	[A]	140.0			166.0			195.0		
Rated output current											
	$I_{N, out}$	[A]	145.0			172.0			202.0		
Rated switching frequency											
	f_{ch}	[kHz]	4								
Output current											
2 kHz	I_{out}	[A]	145.0	160.0	177.0	172.0	195.0	212.0	202.0	240.0	260.0
4 kHz	I_{out}	[A]	145.0			172.0			202.0		
8 kHz	I_{out}	[A]	102.0			120.0			131.0		
16 kHz	I_{out}	[A]									

Data for 60 s overload

Max. output current²⁾											
	$I_{max, out}$	[A]	218.0	195.0	258.0	233.0	303.0	286.0			
Reduced output current²⁾											
	$I_{red, out}$	[A]	109	145	168	129	180	201	152	226	247
Overload time²⁾											
	t_{ol}	[s]	60.0								
Recovery time²⁾											
	t_{re}	[s]	120.0								

Data for 10 s overload

Max. short-time output current²⁾											
	$I_{max, out}$	[A]	261.0	218.0	195.0	310.0	258.0	233.0	364.0	303.0	286.0
Reduced output current²⁾											
	$I_{red, out}$	[A]	109	145	168	129	180	201	152	226	247

¹⁾ 1 - Please refer to the Product key section

²⁾ 10 - See diagram

³⁾ This column applies to an ambient temperature of 40 °C and a fixed switching frequency of 2 kHz.

⁴⁾ The column is valid at an ambient temperature of 40 degrees Celsius, with a fixed switching frequency of 2 kHz and a max. mains voltage of AC 440 V.

Servo Drives 9400 HighLine

Technical data



Rated data for Single Drive

- ▶ The data is valid for operation at 3/PE AC 400 V or DC 565 V.
- ▶ Unless otherwise specified, the data refers to the default setting.

- ▶ Rated data for operation at 3/PE/AC 500 V
DS_9400_0001
Available for download at www.lenze.de/dsc

Typical motor power											
4-pole asynchronous motor	P	[kW]	75.0	85.0	95.0	90.0	105	110	105	125	135
Product key ²⁾			E94AS□E1454			E94AS□E1724			E94AS□E2024		
Rated DC-bus current											
	$I_{N,DC}$	[A]	171.0			203.0			239.0		
Power loss											
	P_V	[W]	2100			2200			2600		
Dimensions											
Height	h	[mm]	897						1166		
Height, including fastening	h	[mm]	930						1199		
Width	b	[mm]				407					
Depth	t	[mm]				427					
Mass											
	m	[kg]	95.0			107.0			109.0		
Max. cable length											
shielded C2 without external measures	l_{max}	[m]				150					
shielded C2 with external measures	l_{max}	[m]				150					

4.4

Brake chopper rated data

Rated power, Brake chopper ¹⁾											
	P_N	[kW]	31.5			36.7			45.1		
Max. output power, Brake chopper ¹⁾											
	$P_{max,1}$	[kW]	105.1			122.2			150.2		
Running time ¹⁾											
	t_{on}	[s]				60.0					
Recovery time ¹⁾											
	t_{re}	[s]				540.0					
Min. brake resistance ¹⁾											
	R_{min}	[Ω]	5.0			4.3			3.5		

²⁾ 1 - Please refer to the Product key section

¹⁾ 10 - See diagram

Servo Drives 9400 HighLine

Technical data



Rated data for Single Drive

- ▶ The data is valid for operation at 3/PE AC 400 V or DC 565 V.
- ▶ Unless otherwise specified, the data refers to the default setting.

- ▶ Rated data for operation at 3/PE/AC 500 V
DS_9400_0001
Available for download at www.lenze.de/dsc

											
Typical motor power											
4-pole asynchronous motor	P	[kW]	130	160 ³⁾	165 ⁴⁾	150	190 ³⁾	210 ⁴⁾	190	235 ³⁾	250 ⁴⁾
Product key¹⁾			E94AS□E2454			E94AS□E2924			E94AS□E3664		
Mains voltage range			3/PE AC 342 V-0 % ... 550 V+0 %, 48 Hz-0 % ... 65 Hz+0 %								
Rated mains current											
With mains choke	$I_{N, AC}$	[A]	237.0			280.0			354.0		
Without mains choke	$I_{N, AC}$	[A]	237.0			280.0			354.0		
Rated output current											
	$I_{N, out}$	[A]	315.0		395.0			443.0			
Rated switching frequency											
	f_{ch}	[kHz]	2								
Output current											
2 kHz	I_{out}	[A]	245.0	302.0	315.0	292.0	361.0	395.0	366.0	443.0	480.0
4 kHz	I_{out}	[A]	209.0		250.0			313.0			
8 kHz	I_{out}	[A]	160.0		191.0			240.0			
16 kHz	I_{out}	[A]									

Data for 60 s overload

Max. output current²⁾													
	$I_{max, out}$	[A]	368.0		347.0		438.0		435.0		549.0		528.0
Reduced output current²⁾													
	$I_{red, out}$	[A]	184	275	299	219	330	375	275	415	456		
Overload time²⁾													
	t_{ol}	[s]	60.0										
Recovery time²⁾													
	t_{re}	[s]	120.0										

Data for 10 s overload

Max. short-time output current²⁾											
	$I_{max, out}$	[A]	441.0	368.0	347.0	526.0	438.0	435.0	659.0	549.0	528.0
Reduced output current²⁾											
	$I_{red, out}$	[A]	184	275	299	219	330	375	275	415	456

¹⁾  1 - Please refer to the Product key section

²⁾  10 - See diagram

³⁾ This column applies to an ambient temperature of 40 °C and a fixed switching frequency of 2 kHz.

⁴⁾ The column is valid at an ambient temperature of 40 degrees Celsius, with a fixed switching frequency of 2 kHz and a max. mains voltage of AC 440 V.

Servo Drives 9400 HighLine

Technical data



Rated data for Single Drive

- ▶ The data is valid for operation at 3/PE AC 400 V or DC 565 V.
- ▶ Unless otherwise specified, the data refers to the default setting.

- ▶ Rated data for operation at 3/PE/AC 500 V
DS_9400_0001
Available for download at www.lenze.de/dsc

											
Typical motor power											
4-pole asynchronous motor	P	[kW]	130	160	165	150	190	210	190	235	250
Product key ²⁾			E94AS□E2454			E94AS□E2924			E94AS□E3664		
Single Drive											
Rated DC-bus current											
	$I_{N,DC}$	[A]	290.0			343.0			434.0		
Power loss											
	P_V	[W]	3300			4100			4900		
Dimensions											
Height	h	[mm]				1546					
Height, including fastening	h	[mm]				1580					
Width	b	[mm]				407					
Depth	t	[mm]				427					
Mass											
	m	[kg]	132.0						161.0		
Max. cable length											
shielded C2 without external measures	l_{max}	[m]				150					
shielded C2 with external measures	l_{max}	[m]				150					

4.4

Brake chopper rated data

Rated power, Brake chopper ¹⁾											
	P_N	[kW]	56.3			68.6			90.1		
Max. output power, Brake chopper ¹⁾											
	$P_{max,1}$	[kW]	187.7			228.5			300.4		
Running time ¹⁾											
	t_{on}	[s]				60.0					
Recovery time ¹⁾											
	t_{re}	[s]				540.0					
Min. brake resistance ¹⁾											
	R_{min}	[Ω]	2.8			2.3			1.8		

²⁾  1 - Please refer to the Product key section

¹⁾  10 - See diagram

Servo Drives 9400 HighLine

Technical data



Rated data for Single Drive

- ▶ The data is valid for operation at 3/PE AC 400 V or DC 565 V.
- ▶ Unless otherwise specified, the data refers to the default setting.

- ▶ Rated data for operation at 3/PE/AC 500 V
DS_9400_0001
Available for download at www.lenze.de/dsc

Typical motor power								
4-pole asynchronous motor	P	[kW]	240	290 ³⁾	315 ⁴⁾	300	320 ³⁾	345 ⁴⁾
Product key¹⁾			E94AS□E4604			E94AS□E5724		
Single Drive			E94AS□E4604			E94AS□E5724		
Mains voltage range			3/PE AC 342 V-0 % ... 550 V+0 %, 48 Hz-0 % ... 65 Hz+0 %					
	U _{AC}	[V]						
Rated mains current								
With mains choke	I _{N, AC}	[A]	444.0			553.0		
Without mains choke	I _{N, AC}	[A]	444.0			553.0		
Rated output current								
	I _{N, out}	[A]	460.0			572.0		
Rated switching frequency			2					
	f _{ch}	[kHz]						
Output current								
2 kHz	I _{out}	[A]	460.0	550.0	600.0	572.0	610.0	658.0
4 kHz	I _{out}	[A]	386.0			458.0		
8 kHz	I _{out}	[A]	260.0			286.0		
16 kHz	I _{out}	[A]						

Data for 60 s overload

Max. output current²⁾								
	I _{max, out}	[A]	690.0		660.0		858.0	
Reduced output current²⁾								
	I _{red, out}	[A]	345	522	570	429	550	625
Overload time²⁾			60.0					
	t _{ol}	[s]						
Recovery time²⁾			120.0					
	t _{re}	[s]						

Data for 10 s overload

Max. short-time output current²⁾								
	I _{max, out}	[A]	828.0	690.0	660.0	1030.0	858.0	724.0
Reduced output current²⁾								
	I _{red, out}	[A]	345	522	570	429	550	625

¹⁾ 1 - Please refer to the Product key section

²⁾ 10 - See diagram

³⁾ This column applies to an ambient temperature of 40 °C and a fixed switching frequency of 2 kHz.

⁴⁾ The column is valid at an ambient temperature of 40 degrees Celsius, with a fixed switching frequency of 2 kHz and a max. mains voltage of AC 440 V.

Servo Drives 9400 HighLine

Technical data



Rated data for Single Drive

- ▶ The data is valid for operation at 3/PE AC 400 V or DC 565 V.
- ▶ Unless otherwise specified, the data refers to the default setting.

- ▶ Rated data for operation at 3/PE/AC 500 V
DS_9400_0001
Available for download at www.lenze.de/dsc

								
Typical motor power								
4-pole asynchronous motor	P	[kW]	240	290	315	300	320	345
Product key ²⁾			E94AS□E4604			E94AS□E5724		
Single Drive								
Rated DC-bus current								
	$I_{N,DC}$	[A]	544.0			677.0		
Power loss								
	P_V	[W]	6200			7200		
Dimensions								
Height	h	[mm]				1559		
Height, including fastening	h	[mm]				1547		
Width	b	[mm]				568		
Depth	t	[mm]				541		
Mass								
	m	[kg]	266.0			278.0		
Max. cable length								
shielded C2 without external measures	l_{max}	[m]				150		
shielded C2 with external measures	l_{max}	[m]				150		

4.4

Brake chopper rated data

Rated power, Brake chopper ¹⁾								
	P_N	[kW]				99.0		
Max. output power, Brake chopper ¹⁾								
	$P_{max,1}$	[kW]	375.0			438.0		
Running time ¹⁾								
	t_{on}	[s]	30.0			28.0		
Recovery time ¹⁾								
	t_{re}	[s]	270.0			272.0		
Min. brake resistance ¹⁾								
	R_{min}	[Ω]	1.4			1.2		

²⁾  1 - Please refer to the Product key section

¹⁾  10 - See diagram

Servo Drives 9400 HighLine

Technical data



Rated data for Single Drive

- ▶ The data is valid for operation at 3/PE AC 400 V or DC 565 V.
- ▶ Unless otherwise specified, the data refers to the default setting.

- ▶ Rated data for operation at 3/PE/AC 500 V
DS_9400_0001
Available for download at www.lenze.de/dsc

Typical motor power								
4-pole asynchronous motor	P	[kW]	335	355 ³⁾	390 ⁴⁾	370	385 ³⁾	420 ⁴⁾
Product key¹⁾			E94AS□E6354			E94AS□E6954		
Single Drive								
Mains voltage range			3/PE AC 342 V-0 % ... 550 V+0 %, 48 Hz-0 % ... 65 Hz+0 %					
	U _{AC}	[V]						
Rated mains current								
With mains choke	I _{N, AC}	[A]	614.0			672.0		
Without mains choke	I _{N, AC}	[A]	614.0			672.0		
Rated output current								
	I _{N, out}	[A]	635.0			800.0		
Rated switching frequency			2					
	f _{ch}	[kHz]						
Output current								
2 kHz	I _{out}	[A]	635.0	678.0	745.0	695.0	730.0	800.0
4 kHz	I _{out}	[A]	508.0			556.0		
8 kHz	I _{out}	[A]	318.0			348.0		
16 kHz	I _{out}	[A]						

Data for 60 s overload

Max. output current²⁾								
	I _{max, out}	[A]	953.0		820.0		1043.0	
Reduced output current²⁾								
	I _{red, out}	[A]	476	610	708	521	653	760
Overload time²⁾			60.0					
	t _{ol}	[s]						
Recovery time²⁾			120.0					
	t _{re}	[s]						

Data for 10 s overload

Max. short-time output current²⁾								
	I _{max, out}	[A]	1143.0	953.0	820.0	1251.0	1043.0	880.0
Reduced output current²⁾								
	I _{red, out}	[A]	476	610	708	521	653	760

¹⁾ 1 - Please refer to the Product key section

²⁾ 10 - See diagram

³⁾ This column applies to an ambient temperature of 40 °C and a fixed switching frequency of 2 kHz.

⁴⁾ The column is valid at an ambient temperature of 40 degrees Celsius, with a fixed switching frequency of 2 kHz and a max. mains voltage of AC 440 V.

Servo Drives 9400 HighLine

Technical data



Rated data for Single Drive

- ▶ The data is valid for operation at 3/PE AC 400 V or DC 565 V.
- ▶ Unless otherwise specified, the data refers to the default setting.

- ▶ Rated data for operation at 3/PE/AC 500 V
DS_9400_0001
Available for download at www.lenze.de/dsc

								
Typical motor power								
4-pole asynchronous motor	P	[kW]	335	355	390	370	385	420
Product key ²⁾			E94AS□E6354			E94AS□E6954		
Single Drive								
Rated DC-bus current								
	$I_{N,DC}$	[A]	752.0			823.0		
Power loss								
	P_V	[W]	7700			7800		
Dimensions								
Height	h	[mm]				1559		
Height, including fastening	h	[mm]				1547		
Width	b	[mm]				568		
Depth	t	[mm]				541		
Mass								
	m	[kg]	300.0			321.0		
Max. cable length								
shielded C2 without external measures	l_{max}	[m]				150		
shielded C2 with external measures	l_{max}	[m]				150		

4.4

Brake chopper rated data

Rated power, Brake chopper ¹⁾							
	P_N	[kW]	99.0				
Max. output power, Brake chopper ¹⁾							
	$P_{max,1}$	[kW]	478.0				
Running time ¹⁾							
	t_{on}	[s]	25.0				
Recovery time ¹⁾							
	t_{re}	[s]	275.0				
Min. brake resistance ¹⁾							
	R_{min}	[Ω]	1.1				

²⁾  1 - Please refer to the Product key section

¹⁾  10 - See diagram

Servo Drives 9400 HighLine

Technical data



Rated data for Multi Drive

- ▶ The data is valid for operation at DC 565 V.
- ▶ Unless otherwise specified, the data refers to the default setting.

					
Typical motor power					
4-pole asynchronous motor	P	[kW]	0.37	0.75	1.50
Product key⁻¹⁾					
Multi Drive			E94AM□E0024	E94AM□E0034	E94AM□E0044
DC supply					
	U _{DC}	[V]	DC 260 V -0 % ... 775 V +0 %		
Rated output current					
	I _{N, out}	[A]	1.5	2.5	4.0
Rated switching frequency					
	f _{ch}	[kHz]	8		
Output current					
2 kHz	I _{out}	[A]	1.9	3.1	5.0
4 kHz	I _{out}	[A]	1.9	3.1	5.0
8 kHz	I _{out}	[A]	1.5	2.5	4.0
16 kHz	I _{out}	[A]	1.1	1.9	3.0

4.4

Data for 60 s overload

Max. output current²⁾					
	I _{max, out}	[A]	2.8	4.7	7.5
Reduced output current²⁾					
	I _{red, out}	[A]	1.40	2.30	3.80
Overload time²⁾					
	t _{ol}	[s]	60.0		
Recovery time²⁾					
	t _{re}	[s]	120.0		

Data for 0.5 s overload

Max. short-time output current²⁾					
	I _{max, out}	[A]	6.0	10.0	16.0
Reduced output current²⁾					
	I _{red, out}	[A]	1.40	2.30	3.80
Overload time²⁾					
	t _{ol}	[s]	0.5		
Recovery time²⁾					
	t _{re}	[s]	4.5		

¹⁾  1 - Please refer to the Product key section

²⁾  10 - See diagram

Servo Drives 9400 HighLine



Technical data



Rated data for Multi Drive

- ▶ The data is valid for operation at DC 565 V.
- ▶ Unless otherwise specified, the data refers to the default setting.

					
Typical motor power					
4-pole asynchronous motor	P	[kW]	0.37	0.75	1.50
Product key¹⁾					
Multi Drive			E94AM□E0024	E94AM□E0034	E94AM□E0044
Rated DC-bus current					
	$I_{N, DC}$	[A]	2.6	4.3	6.7
Power loss					
	P_V	[W]	100	120	150
Dimensions					
Height	h	[mm]		350	
Height, including fastening	h	[mm]		481	
Width	b	[mm]		60	
Depth	t	[mm]		288	
Mass					
	m	[kg]		4.0	
Max. cable length					
shielded C1 with external measures	l_{max}	[m]		25	
shielded C2 without external measures	l_{max}	[m]		10	
shielded C2 with external measures	l_{max}	[m]	50		100

¹⁾   1 - Please refer to the Product key section



Servo Drives 9400 HighLine

Technical data



Rated data for Multi Drive

- ▶ The data is valid for operation at DC 565 V.
- ▶ Unless otherwise specified, the data refers to the default setting.

					
Typical motor power					
4-pole asynchronous motor	P	[kW]	3.00	4.00	5.50
Product key⁻¹⁾					
Multi Drive			E94AM□E0074	E94AM□E0094	E94AM□E0134
DC supply			DC 260 V -0 % ... 775 V +0 %		
	U _{DC}	[V]			
Rated output current					
	I _{N, out}	[A]	7.0	9.3	13.0
Rated switching frequency					
	f _{ch}	[kHz]	8		
Output current					
2 kHz	I _{out}	[A]	8.8	11.7	16.3
4 kHz	I _{out}	[A]	8.8	11.7	16.3
8 kHz	I _{out}	[A]	7.0	9.3	13.0
16 kHz	I _{out}	[A]	5.3	7.0	9.8

4.4

Data for 60 s overload

Max. output current²⁾					
	I _{max, out}	[A]	13.1	17.5	24.4
Reduced output current²⁾					
	I _{red, out}	[A]	6.60	8.80	12.2
Overload time²⁾					
	t _{ol}	[s]	60.0		
Recovery time²⁾					
	t _{re}	[s]	120.0		

Data for 0.5 s overload

Max. short-time output current²⁾					
	I _{max, out}	[A]	21.0	28.0	39.0
Reduced output current²⁾					
	I _{red, out}	[A]	6.60	8.80	12.2
Overload time²⁾					
	t _{ol}	[s]	0.5		
Recovery time²⁾					
	t _{re}	[s]	4.5		

¹⁾  1 - Please refer to the Product key section

²⁾  10 - See diagram



Servo Drives 9400 HighLine

Technical data





Rated data for Multi Drive

- ▶ The data is valid for operation at DC 565 V.
- ▶ Unless otherwise specified, the data refers to the default setting.

					
Typical motor power					
4-pole asynchronous motor	P	[kW]	3.00	4.00	5.50
Product key⁻¹⁾					
Multi Drive			E94AM□E0074	E94AM□E0094	E94AM□E0134
Rated DC-bus current					
	$I_{N, DC}$	[A]	12.1	15.4	20.6
Power loss					
	P_V	[W]	190	230	280
Dimensions					
Height	h	[mm]		350	
Height, including fastening	h	[mm]		481	
Width	b	[mm]	90		120
Depth	t	[mm]		288	
Mass					
	m	[kg]	5.3		8.1
Max. cable length					
shielded C1 with external measures	l_{max}	[m]		25	
shielded C2 without external measures	l_{max}	[m]		10	
shielded C2 with external measures	l_{max}	[m]		100	

4.4

¹⁾   1 - Please refer to the Product key section

Servo Drives 9400 HighLine

Technical data



Rated data for Multi Drive

- ▶ The data is valid for operation at DC 565 V.
- ▶ Unless otherwise specified, the data refers to the default setting.

					
Typical motor power					
4-pole asynchronous motor	P	[kW]	7.50	11.0	15.0
Product key⁻¹⁾					
Multi Drive			E94AM□E0174	E94AM□E0244	E94AM□E0324
DC supply			DC 260 V -0 % ... 775 V +0 %		
	U _{DC}	[V]			
Rated output current					
	I _{N, out}	[A]	16.5	23.5	32.0
Rated switching frequency			8		
	f _{ch}	[kHz]			
Output current					
2 kHz	I _{out}	[A]	20.6	29.4	40.0
4 kHz	I _{out}	[A]	20.6	29.4	40.0
8 kHz	I _{out}	[A]	16.5	23.5	32.0
16 kHz	I _{out}	[A]	12.4	17.6	24.0

4.4

Data for 60 s overload

Max. output current²⁾					
	I _{max, out}	[A]	30.9	44.1	60.0
Reduced output current²⁾					
	I _{red, out}	[A]	15.5	22.1	30.0
Overload time²⁾			60.0		
	t _{ol}	[s]			
Recovery time²⁾			120.0		
	t _{re}	[s]			

Data for 0.5 s overload

Max. short-time output current²⁾					
	I _{max, out}	[A]	49.5	70.5	76.8
Reduced output current²⁾					
	I _{red, out}	[A]	15.5	22.1	30.0
Overload time²⁾			0.5		
	t _{ol}	[s]			
Recovery time²⁾			4.5		
	t _{re}	[s]			

¹⁾  1 - Please refer to the Product key section

²⁾  10 - See diagram

Servo Drives 9400 HighLine



Technical data



Rated data for Multi Drive

- ▶ The data is valid for operation at DC 565 V.
- ▶ Unless otherwise specified, the data refers to the default setting.

					
Typical motor power					
4-pole asynchronous motor	P	[kW]	7.50	11.0	15.0
Product key¹⁾					
Multi Drive			E94AM□E0174	E94AM□E0244	E94AM□E0324
Rated DC-bus current					
	$I_{N, DC}$	[A]	25.7	35.5	48.0
Power loss					
	P_V	[W]	320	420	490
Dimensions					
Height	h	[mm]		350	
Height, including fastening	h	[mm]		481	
Width	b	[mm]		120	
Depth	t	[mm]		288	
Mass					
	m	[kg]		8.1	
Max. cable length					
shielded C1 with external measures	l_{max}	[m]		25	
shielded C2 without external measures	l_{max}	[m]		10	
shielded C2 with external measures	l_{max}	[m]		100	

¹⁾   1 - Please refer to the Product key section

Servo Drives 9400 HighLine

Interfaces



Mains connection

- ▶ The mains fuse and cable cross-section specifications are for a mains connection of 1 x 230V or 3 x 400V.
- ▶ Class gG/gI fuses or class gRL semiconductor fuses.
- ▶ The cable cross-sections apply to PVC-insulated copper cables.
- ▶ Use for installation with UL-approved cables, fuses and brackets.

Operation with mains choke

Typical motor power	Mains voltage	Product key	Circuit breaker	Fuse		Mains connection
				EN 60204-1	UL	
4-pole asynchronous motor		Single Drive				Cross-section (with mains choke)
P	U_{AC}		I	I	I	q
[kW]	[V]		[A]	[A]	[A]	[mm ²]
0.37	3 AC 180... 550	E94AS□E0024	C10	10	10	1.5
0.75		E94AS□E0034				
1.50		E94AS□E0044				
3.00		E94AS□E0074	C16	16	15	2.5
5.50		E94AS□E0134	C20	20	20	
7.50		E94AS□E0174	C25	32	25	4.0
11.0		E94AS□E0244	C32		30	10.0

4.4



Interfaces

Mains connection

- ▶ The mains fuse and cable cross-section specifications are for a mains connection of 1 x 230V or 3 x 400V.
- ▶ Class gG/gI fuses or class gRL semiconductor fuses.
- ▶ The cable cross-sections apply to PVC-insulated copper cables.
- ▶ Use for installation with UL-approved cables, fuses and brackets.

Operation without mains choke

Typical motor power	Mains voltage	Product key	Circuit breaker	Fuse		Mains connection			
				EN 60204-1	UL				
4-pole asynchronous motor		Single Drive				Cross-section (without mains choke)			
P	U_{AC}		I	I	I	q			
[kW]	[V]		[A]	[A]	[A]	[mm ²]			
0.37	3 AC 180... 550	E94AS□E0024	C10	10	10	1.5			
0.75		E94AS□E0034							
1.50		E94AS□E0044							
3.00		E94AS□E0074	C16	16	15	2.5			
5.50		E94AS□E0134	C20	20	20				
7.50		E94AS□E0174	C25	32	25	4.0			
11.0		E94AS□E0244	C40	50	40	40	10.0		
15.0		E94AS□E0324							
22.0		E94AS□E0474					63	60	16.0
30.0		E94AS□E0594					80	80	25.0
45.0		E94AS□E0864					100	100	50.0
55.0		E94AS□E1044					125	125	70.0
75.0		E94AS□E1454					200	250	
90.0		E94AS□E1724					250	300	95.0
105	E94AS□E2024		315				350	150.0	
130	E94AS□E2454		350				200		
150	E94AS□E2924		400	250	185.0				
190	E94AS□E3664		500	300	240.0				
240	E94AS□E4604		350	350	150.0				
300	E94AS□E5724		400	400	185.0				
335	E94AS□E6354		450						
370	E94AS□E6954		500		240.0				

Servo Drives 9400 HighLine

Interfaces



Motor connection

- ▶ Keep motor cables as short as possible, as this has a positive effect on the drive behaviour.
- ▶ With group drives (multiple motors on one inverter), the resulting cable length is the key factor. This can be calculated using the hardware manual.
- ▶ Electric strength of the motor cable: 1 kV as per VDE 250-1.

Typical motor power	Mains voltage	Product key	Max. cable length		
			shielded C1 with external measures	shielded C2 without external measures	shielded C2 with external measures
4-pole asynchronous motor		Single Drive			
P	U_{AC}		I_{max}	I_{max}	I_{max}
[kW]	[V]		[m]	[m]	[m]
0.37	3 AC 180... 550	E94AS□E0024	25	10	50
0.75		E94AS□E0034			
1.50		E94AS□E0044			
3.00		E94AS□E0074			
5.50		E94AS□E0134			
7.50		E94AS□E0174			100
11.0		E94AS□E0244			
15.0		E94AS□E0324			
22.0		E94AS□E0474			
30.0		E94AS□E0594			
45.0	E94AS□E0864	50	50	150	
55.0	E94AS□E1044				
75.0	E94AS□E1454				
90.0	E94AS□E1724				
105	E94AS□E2024				
130	E94AS□E2454				
150	E94AS□E2924				
190	E94AS□E3664				
240	E94AS□E4604				
300	E94AS□E5724				
335	E94AS□E6354				
370	E94AS□E6954				

4.4



Connection diagrams

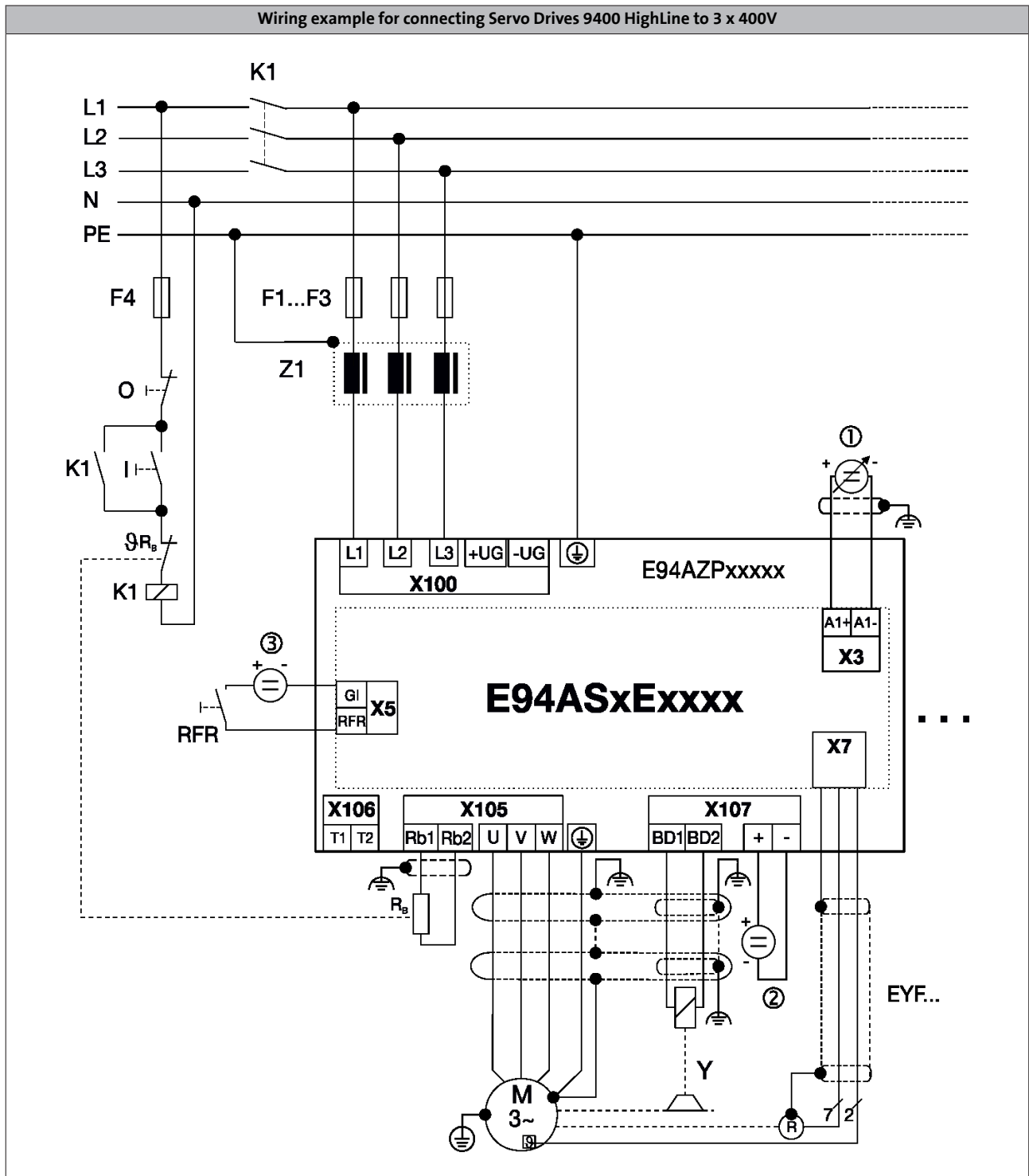

Servo Drives 9400 HighLine

Interfaces



Control connections

Mode	Servo Drives 9400 HighLine
Analog inputs	
Number	2
Resolution	11 bits + sign
Value range	+/- 10V 1 x switchable 20 mA
Analog outputs	
Number	2
Resolution	10 bits + sign
Value range	+/- 10V max. 2 mA
Digital inputs	
Number	8
Touch-probe-capable	8
Switching level	PLC (IEC 61131-2)
Max. input current	8 mA
Digital outputs	
Number	4
Switching level	PLC (IEC 61131-2)
Max. output current	50 mA
Load capacity	>480 Ω at 24 V
External DC supply	
Rated voltage	24 V in accordance with IEC 61131-2
Voltage range	19.2 ... 28.8 V, max. residual ripple ± 5%
Current	Single Drive: approx. 1.2 A during operation, max. 3 A starting current for 100 ms ¹⁾ Multi Drive: approx. 2.4 A during operation, max. 4 A starting current for 100 ms
Interfaces	
CANopen	Integrated
Extensions	Via slot MXI 2: extension 2 Via slot MXI 1: extension 1
State bus	Integrated
Memory	Slot MMI
Safety engineering	Slot MSI
Drive interface	
Resolver input	Integrated Sub-D, 9-pin
Encoder input	Sub-D, 15-pin Multiple encoder input for: SinCos/TTL incremental encoder, SinCos absolute value encoder single-turn/multi-turn (HIPERFACE® / Endat V2.1) SSI encoder with Stegmann SSI protocol as position encoder or master encoder with minimum cycle time of 1 ms
Motor temperature	Input on the device: PTC evaluation Via feedback: KTY evaluation
Motor brake	Optional, in installation backplane up to 32 A or in axis module from 32 A

¹⁾ The supply voltage for the control electronics comes from the mains voltage. Alternatively, it can be provided by a 24 V supply that is independent of the mains (available as an option).

Servo Drives 9400 HighLine

Interfaces



Control connections

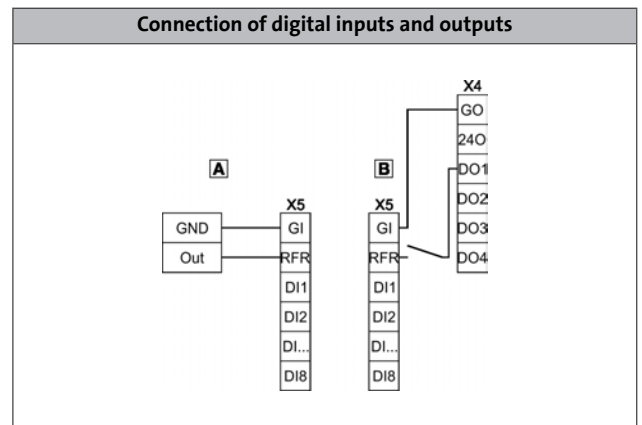
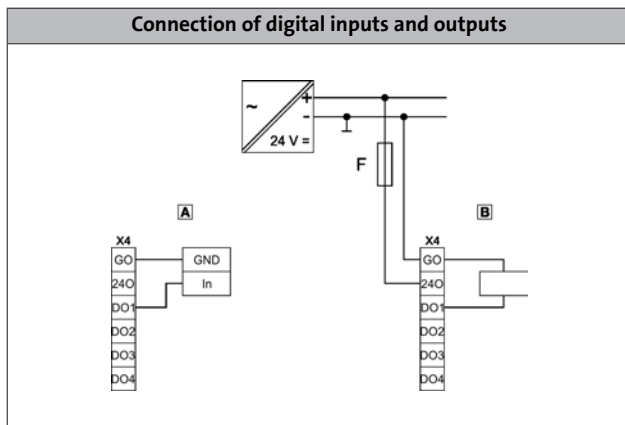
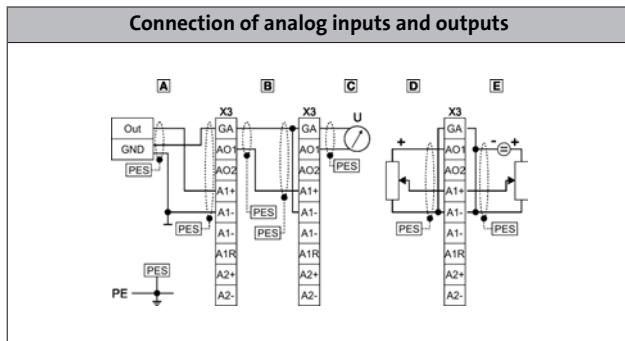

4.4

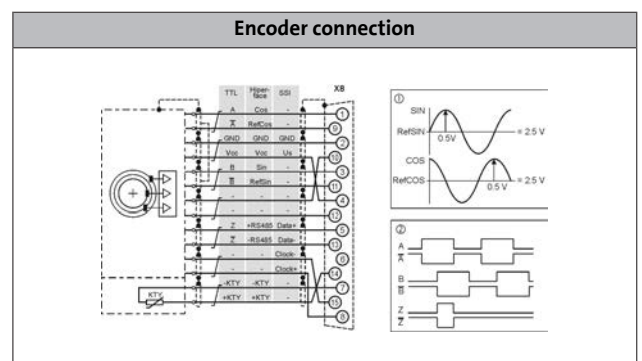
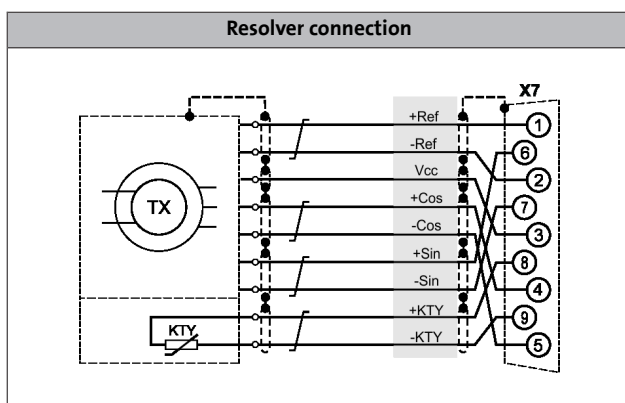

Servo Drives 9400 HighLine

Interfaces



Overview of modules

For adaptation to the machine requirements, up to four different modules can be used to adjust the Servo Drives 9400 and regenerative power supply modules. The following slots are available:



- memory modules:
(slot MMI) required for operation,
- safety modules:
(slot MSI) required for operation
- extension modules:
(slot MXI 1 and/or MXI 2)



Axis module with module slots MXI, MMI and MSI

The tables below show the modules available for Servo Drive 9400 and the regenerative power supply modules.

Memory module

Slot	Image	Mode Memory module	Product key	Mode	
				HighLine	Regen. module
MMI		Motion control HighLevel MM220	E94AYM22	Standard	Standard
MMI		Motion control TopLevel MM330	E94AYM33	Option	
MMI		Motion control TopLevel MM430	E94AYM43	Option	

4.4



Servo Drives 9400 HighLine

Interfaces



Overview of modules

Safety modules

Slot		Mode			
		Safety module	Product key	HighLine	Regen. module
MSI		SM0	E94AYAA	Standard	Standard
MSI		SM100	E94AYAB	Option	
MSI		SM301	E94AYAE	Option	

Servo Drives 9400 HighLine

Interfaces





Overview of modules

Extension modules

Slot		Mode	Product key	Mode	
				Extension module	HighLine
MXI1 MXI2		Digital frequency	E94AYFLF	Option	

Communication modules

Slot		Mode	Product key	Mode	
				Communication module	HighLine
MXI1 MXI2		CANopen	E94AYCCA	Option	Option
MXI1 MXI2		DeviceNet	E94AYCDN	Option	Option
MXI1 MXI2		EtherCAT	E94AYCET	Option	Option
MXI1 MXI2		EtherNet/IP EtherNet/IP STO	E94AYCEN	Option	Option
MXI1 MXI2		POWERLINK MN/CN	E94AYCEP	Option	
MXI1 MXI2		POWERLINK CN	E94AYCEC	Option	
MXI1 MXI2		PROFIBUS	E94AYCPM	Option	Option
MXI1 MXI2	 	PROFINET	E94AYCER	Option	Option

4.4

Servo Drives 9400 HighLine

Interfaces



Overview of modules

Assignment of extension modules and module slots (HighLine)

Two module slots on the Servo Drives 9400 are intended for extensions. The following table lists the possible combinations.

MXI 1	E94AYFLF	E94AYCCA	E94AYCDN	E94AYCET	E94AYCEN	E94AYCEP	E94AYCEC	E94AYCPM	E94AYCER
MXI 2									
E94AYFLF		•	•	•	•	•	•	•	•
E94AYCCA	•			•	•	•	•	•	•
E94AYCDN	•				•	•	•	•	•
E94AYCET	•	•			•				•
E94AYCEN	•	•	•	•		•	•	•	•
E94AYCEP	•	•	•		•			•	•
E94AYCEC	•	•	•		•				
E94AYCPM ¹⁾	•	•	•		•	•			•
E94AYCER ¹⁾	•	•	•	•	•	•		•	

¹⁾ Module slot MXI 1 must be used for PROFI-safe.

Assignment of extension modules and the module slot for the regenerative power supply module

Two module slots on the regenerative power supply modules are intended for extensions. The following table lists the possible combinations.

MXI 1	E94AYCCA	E94AYCDN	E94AYCET	E94AYCEN	E94AYCPM	E94AYCER
MXI 2						
E94AYCCA			•	•	•	•
E94AYCDN				•	•	•
E94AYCET	•	•		•		
E94AYCEN	•	•	•		•	•
E94AYCPM	•	•		•		
E94AYCER	•	•	•	•		

Servo Drives 9400 HighLine

Interfaces



Memory module

Various memory modules are available for the Servo Drives 9400:

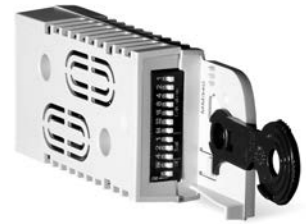

- Motion Control HighLevel (MM220)
- Motion Control TopLevel (MM330 and MM430)

With these modules, the functions described below are activated. The functions can be loaded into the drive using L-force Engineer. In addition to the different functions of the Runtime software versions, different memory sizes or a real-time clock function (battery-backed) are available, depending on which memory module is used.



MM330 memory module

4.4

Mode		Features	Slot	Product key
Memory module				
Motion control HighLevel MM220		<ul style="list-style-type: none"> • Application and parameter storage • Functional range of HighLevel Motion Control with Servo Drives 9400 HighLine: <ul style="list-style-type: none"> - Speed actuating drive - Torque actuating drive - Electronic gearbox - Synchronism using mark synchronisation - Table positioning - Expansion/adaptation by means of function block editor In conjunction with regenerative power supply module: <ul style="list-style-type: none"> - operation of the regenerative power supply module - expansion/adaptation by means of function block editor • Address switch and baud rate setting for onboard system bus CANopen 	MMI	E94AYM22
Motion control TopLevel MM330		<ul style="list-style-type: none"> • Application and parameter storage • Functional range of Motion Control TopLevel with Servo Drives 9400 HighLine: <ul style="list-style-type: none"> - Speed actuating drive - Torque actuating drive - Electronic gearbox - Synchronism using mark synchronisation - Table positioning - Positioning sequence control (graphical sequencer) - Expansion/adaptation by means of function block editor - Function blocks with cam functionality • Address switch and baud rate setting for onboard system bus CANopen 	MMI	E94AYM33

Servo Drives 9400 HighLine

Interfaces



Memory module

Mode		Features	Slot	Product key
Memory module				
Motion control TopLevel MM430		<ul style="list-style-type: none"> • Application and parameter storage • Functional range of Motion Control TopLevel with Servo Drives 9400 HighLine: <ul style="list-style-type: none"> - Speed actuating drive - Torque actuating drive - Electronic gearbox - Synchronism using mark synchronisation - Table positioning - Positioning sequence control (graphical sequencer) - Expansion/adaptation by means of function block editor - Function blocks with cam functionality • Address switch and baud rate setting for onboard system bus CANopen • Real-time clock (battery-buffered) 	MMI	E94AYM43

Product key		E94AYM22	E94AYM33	E94AYM43
Mode		Motion control HighLevel MM220	Motion control TopLevel MM330	Motion control TopLevel MM430
Storage medium				
Flash memory	[MB]	2.00	4.00	8.00
Additional function		No		Yes
Real-time clock		No		Yes
System bus addressing switch (CAN)		Yes		

4.4

Servo Drives 9400 HighLine

Interfaces



Safety modules

For virtually any application, the provision of extensive safety engineering is one of the most important tasks of the plant constructor. However, this issue can only be solved with the help of complicated wiring. Thanks to the "Drive-based Safety" solution that can be integrated in servo drives 9400, this can be implemented using axis modules. The safety engineering, which can be integrated as an option, has a modular structure.

The range of functions begins with the "safe torque off" function (formerly "safe standstill") and extends as far as integration in safety bus systems. The modular approach of drive-based safety also provides the option for expanding systems in future and, at the same time, ensures flexibility.



The following modules are available with safety functions in accordance with IEC 61800-5-2:

- SM0 (necessary for the MSI slot if no safety functions are required)
- SM100
- SM301



SM301 safety module

4.4

Mode		Features	Slot	Product key
Safety module				
SM0		<ul style="list-style-type: none"> • No safety functions 		E94AYAA
SM100		<ul style="list-style-type: none"> • 1 safe input for active sensors, 1 monitor (1-channel output) • Control category 4 in acc. with EN 954-1, PLe in acc. with EN ISO 13849-1, SIL3 in acc. with EN IEC 62061 • Safe torque off (STO) 		E94AYAB
SM301		<ul style="list-style-type: none"> • 1 safe output, parameterisable • 4 safe inputs, for active or passive sensors • Safe torque off (STO) • Safe stop 1 (SS1) • Safe stop 2 (SS2)¹⁾ • Safe operational stop (SOS)¹⁾ • Safely limited speed (SLS)¹⁾ • Safe maximum speed (SMS)¹⁾ • Safe direction (SDI) of motion¹⁾ • Operation mode selector (OMS) with confirmation (ES)¹⁾ • Safe speed monitor (SSM)¹⁾ • Safely limited increment (SLI)¹⁾ • PROFI-safe safety bus via PROFIBUS DP and PROFINET I/O (optional) • Choice of 1-encoder or 2-encoder evaluation • Control category 3 in acc. with EN 954-1, PLe in acc. with EN ISO 13849-1, SIL3 in acc. with EN IEC 62061 	MSI	E94AYAE

¹⁾ For speed-dependent safety functions, the motor-feedback system combinations listed on the following page are available.



Safety modules

Product key			E94AYAA	E94AYAB	E94AYAE
Mode					
Safety module			SM0	SM100	SM301
Certification					
EN 954-1				Category 4	Category 3
EN ISO 13849-1				PLe	PLe
Fail-safe state					
				Safe torque off	Safe torque off
Safe inputs/outputs					
Number of connectable active safety sensors				1	4, choice between active or passive
Number of connectable passive safety sensors					4, choice between active or passive
Monitor (1-channel output)				1	
Safety bus					
PROFIsafe ¹⁾					PROFIBUS DP, PROFINET IO communication module (optional)
Diagnostics					
Status display				2 LEDs	6 LEDs
Rated voltage					
			$U_{N,DC}$ [V]	24.0	24.0

¹⁾ Module slot MXI 1 must be used for PROFIsafe.

Speed-dependent safety functions in connection with the SM301 safety module

For the following speed-dependent safety functions, the motor-feedback system combinations listed in the following table are available:

- Safe stop 1 (SS1)
- Safe operational stop (SOS)
- Safely Limited Speed (SLS)
- Safe Maximum Speed (SMS)

- Safe direction (SDI)
- Operation mode selector (OMS) with confirmation (ES)
- Safe speed monitor (SSM)
- Safely limited increment (SLI).

	Encoder type	Encoder type	Product key		Safe speed monitoring
Synchronous servo motors (MCS, MDXKS)	SinCos absolute value	Single-turn	AS1024-8V-K2	2-encoder concept	PL d/SIL 2
		Multi-turn	AM1024-8V-K2		PL e/SIL 3
	Resolver		RV03		up to PL e / SIL 3

	Encoder type	Encoder type	Product key		Safe speed monitoring
Asynchronous servo motors (MCA, MQA)	SinCos incremental	Single-turn	IG1024-5V-V3	2-encoder concept	PL e/SIL 3
			RV03		up to PL e / SIL 3
	Resolver				

Please refer to the servo motors catalogue for details on the concrete assignments of the individual motor frame sizes and the corresponding technical properties.

A "2-encoder concept" is a resolver as motor feedback unit and, at the same time, an absolute value encoder (SinCos), and incremental encoder (TTL), an SSI encoder or bus encoder as position encoder at the machine

Servo Drives 9400 HighLine

Interfaces



Extension module: digital frequency

Some applications require several axes to be operated in synchronism. What was formerly implemented by means of the line shaft, can now be achieved in the Servo Drives 9400 HighLine with the digital frequency extension module. The extension module provides a digital frequency input and output. The signals of the different axes can thus be looped through and simulated.



Extension module: digital frequency

4.4

Mode		Features	Slot	Product key
Communication module				
		<ul style="list-style-type: none"> • Digital frequency 0 to 500 kHz • Up to three slave drives connectable • Sub-D connection for LFin and Lfout 	MX11 MX12	E94AYFLF

Standards and operating conditions

Product key				E94AYFLF
Mode				
Communication module				
Enclosure				IP20
EN 60529				
Vibration resistance				Sinusoidal vibration Amplitude/Acceleration Acceleration resistant up to 0.7 g acc. to Germanischer Lloyd 10 Hz ≤ f ≤ 57 Hz: ±0.075 mm amplitude,
Site altitude				
Amsl	H _{max}	[m]		4000
Climatic conditions				
Storage (EN 60721-3-1)				1K3 (temperature: -25 °C ... +60 °C)
Transport (EN 60721-3-2)				2K3 (temperature: -25 °C ... +70 °C)
Operation (EN 60721-3-3)				3K3 (temperature: -10°C ... +55°C)
Insulation voltage to reference earth/PE				
	U _{AC}	[V]		50.0

Servo Drives 9400 HighLine

Interfaces



Extension module: digital frequency

Rated data

Product key			E94AYFLF
Mode			
System cables			Type: EYD
Digital frequency			
Input	f	[kHz]	0 to 500 (TTL)
Output	f	[kHz]	0 to 500 (TTL)
Feedback			
Incremental encoder type			TTL encoder
Incremental encoder signal			2 signals of 5 V offset by 90°
Sequence connections			
In parallel			3 drives
In series			For 250 kHz 20 drives For 500 kHz 10 drives
Max. cable length			
between two nodes	I_{\max}	[m]	50
Rated voltage			
	$U_{N,DC}$	[V]	24.0

Servo Drives 9400 HighLine

Interfaces



Communication module: CANopen

The Servo Drives 9400 HighLine and the regenerative power supply modules have a CANopen interface on board as a standard feature. It enables the axis modules to communicate with each other and with other system bus components (e.g. I/O systems or HMIs). If a second CANopen interface is necessary for system networking, the CANopen communication module can be used for this purpose. CANopen is a communication protocol based on CAN physics. Its specifications are determined by the CiA user group (CAN in Automation). Compatibility with the Lenze system bus (CAN) can be established by means of configuration.



Communication module: AS-Interface

4.4

Mode		Features	Slot	Product key
Communication module				
CANopen		<ul style="list-style-type: none"> CANopen profile DS301, V4.02 Lenze system bus Automatic baud rate detection 2 LEDs for communication status display DIP switch for selecting baud rate and address Sub-D connection 	MX11 MX12	E94AYCCA

Standards and operating conditions

Product key				E94AYCCA
Mode				CANopen
Enclosure				IP20
Vibration resistance				Sinusoidal vibration Amplitude/Acceleration Acceleration resistant up to 0.7 g acc. to Germanischer Lloyd 5 Hz ≤ f ≤ 13.2 Hz ± 1 mm amplitude, 13.2 Hz ≤ f ≤ 100 Hz: 10 Hz ≤ f ≤ 57 Hz: ±0.075 mm amplitude,
Site altitude				4000
Amsl	H _{max}	[m]		
Climatic conditions				
Storage (EN 60721-3-1)				1K3 (temperature: -25 °C ... +60 °C)
Transport (EN 60721-3-2)				2K3 (temperature: -25 °C ... +70 °C)
Operation (EN 60721-3-3)				3K3 (temperature: -10°C ... +55°C)
Insulation voltage to reference earth/PE				50.0
	U _{AC}	[V]		

Servo Drives 9400 HighLine

Interfaces



Communication module: CANopen

Rated data

Product key			E94AYCCA
Communication			
Medium			DIN ISO 11898
Communication profile			CANopen, DS301 V4.02 Lenze system bus
Baud rate			
	b	[kBit/s]	10 20 50 125 250 500 800 1000
Node			
			Slave Multi-master
Network topology			
			Line with terminating resistors (120 ohm) at both ends
Number of logical process data channels			
			4 (each with 1 - 8 bytes)
Number of logic parameter data channels			
			5
Number of bus nodes			
			127 Without repeaters: 110
Max. cable length			
between two nodes	l_{max}	[m]	100
per bus segment ¹⁾	l_{max}	[m]	17 for 1000 kbps 40 for 800 kbps 110 for 500 kbps 290 for 250 kbps 630 for 125 kbps 1500 for 50 kbps 3900 for 20 kbps 8000 for 10 kbps
Rated voltage			
	$U_{N,DC}$	[V]	24.0

¹⁾ Max. bus cable lengths also depend on the number of nodes and the cable cross-section used.

Servo Drives 9400 HighLine

Interfaces



DeviceNet communication module

The American automation specialist Allan Bradley developed the DeviceNet fieldbus based on the CAN controller. This communication profile is published by the ODVA (Open DeviceNet Vendor Association) user organisation. A large number of sensors and actuators are available. Similar to CANopen, a DeviceNet master is used to control the DeviceNet.



DeviceNet communication module

4.4

Mode		Features	Slot	Product key
Communication module				
DeviceNet		<ul style="list-style-type: none"> • "Group 2 Only Server" functionality (slave) • DIP switch for selecting baud rate and address • 1 LED for communication status display • Push-on terminal strip with screw connection, 5-pin 	MXI1 MXI2	E94AYCDN

Standards and operating conditions

Product key			E94AYCDN
Mode			DeviceNet
Enclosure			IP20
EN 60529			
Vibration resistance			Sinusoidal vibration Amplitude/Acceleration Acceleration resistant up to 0.7 g acc. to Germanischer Lloyd 10 Hz ≤ f ≤ 57 Hz: ±0.075 mm amplitude,
Site altitude			4000
Amsl	H _{max}	[m]	
Climatic conditions			
Storage (EN 60721-3-1)			1K3 (temperature: -25 °C ... +60 °C)
Transport (EN 60721-3-2)			2K3 (temperature: -25 °C ... +70 °C)
Operation (EN 60721-3-3)			3K3 (temperature: -10°C ... +55°C)
Insulation voltage to reference earth/PE			
	U _{AC}	[V]	50.0

Servo Drives 9400 HighLine

Interfaces



DeviceNet communication module

Rated data

Product key			E94AYCDN
Communication			
Medium			DIN ISO 11898
Communication profile			DeviceNet
Baud rate			
	b	[kBit/s]	125 250 500
Node			Slave
Network topology			Line with terminating resistors (120 ohm) at both ends
Process data words (PZD)			
16 Bit			32
Number of bus nodes			Max. 64
Max. cable length			
per bus segment	I_{max}	[m]	100 for 500 kbps, Thick Cable 250 for 250 kbps, Thick Cable 500 for 125 kbps, Thick Cable 100 for 500 kbps, Thin Cable 100 for 250 kbps, Thin Cable 100 for 125 kbps, Thin Cable
Rated voltage			
	$U_{N,DC}$	[V]	24.0

4.4

Servo Drives 9400 HighLine

Interfaces



EtherCAT® communication module

Physically speaking, EtherCAT® is a ring system that uses a one-total-frame protocol, where the device manipulates the data during the cycle. It has two physical variants, the E-bus and Ethernet. E-bus is only suitable for short distances within a device; only the Ethernet version offers the benefits of an Ethernet system.



EtherCAT® communication module

4.4

Mode		Features	Slot	Product key
Communication module				
EtherCAT		<ul style="list-style-type: none"> • CANopen over EtherCAT (CoE) • Distributed clock • 2 RJ45 connections with LEDs for link and activity • 2 LEDs for communication status display • External voltage supply possible 	MXI1 MXI2	E94AYCET

Standards and operating conditions

Product key				E94AYCET
Mode				EtherCAT
Enclosure				IP20
EN 60529				
Vibration resistance				Sinusoidal vibration Amplitude/Acceleration Acceleration resistant up to 0.7 g acc. to Germanischer Lloyd 10 Hz ≤ f ≤ 57 Hz: ±0.075 mm amplitude,
Site altitude				4000
Amsl	H _{max}	[m]		
Climatic conditions				
Storage (EN 60721-3-1)				1K3 (temperature: -25 °C ... +60 °C)
Transport (EN 60721-3-2)				2K3 (temperature: -25 °C ... +70 °C)
Operation (EN 60721-3-3)				3K3 (temperature: -10°C ... +55°C)
Insulation voltage to reference earth/PE				50.0
	U _{AC}	[V]		

Servo Drives 9400 HighLine

Interfaces



EtherCAT® communication module

Rated data

Product key			E94AYCET
Communication			
Medium			CAT5e S/FTP according to ISO/ICE11801 (2002)
Communication profile			CoE (CANopen over EtherCAT)
Baud rate			
	b	[MBit/s]	100
Node			
			Slave
Network topology			
			Line (internal ring)
Number of logical process data channels			
			1
Process data words (PZD)			
16 Bit			1 ... 32
Number of bus nodes			
			Max. 65535
Max. cable length			
between two nodes	I_{max}	[m]	100
Rated voltage			
	$U_{N, DC}$	[V]	24.0

Servo Drives 9400 HighLine

Interfaces



EtherNet/IP communication module

Initially the EtherNet/IP network was reserved for the office, but today this communication system is also often used for system parameterisation. The Servo Drives 9400 can be expanded for this purpose using an EtherNet/IP module.

The EtherNet/IP module can be integrated into general IT infrastructures (e.g. control centres, production data acquisition) and is suitable for remote maintenance applications. It is intended for parameter setting, but not for real-time transmission of process data.



EtherNet/IP communication module

4.4

Mode		Features	Slot	Product key
Communication module				
EtherNet/IP EtherNet/IP STO		<ul style="list-style-type: none"> • Automatic setting of baud rate and transmission mode • 2 RJ45 connections with LEDs for link and activity • Automatic detection of wiring errors and polarity reversal • Integrated 2-port switch • Electrical isolation from the bus • Automatic switching between transmit and receive paths (auto-crossing) 	MXI1 MXI2	E94AYCEN

Standards and operating conditions

Product key			E94AYCEN
Mode			EtherNet/IP EtherNet/IP STO
Enclosure			IP20
EN 60529			
Vibration resistance			Sinusoidal vibration Amplitude/Acceleration Acceleration resistant up to 0.7 g acc. to Germanischer Lloyd 10 Hz ≤ f ≤ 57 Hz: ±0.075 mm amplitude,
Site altitude			4000
Amsl	H _{max}	[m]	
Climatic conditions			
Storage (EN 60721-3-1)			1K3 (temperature: -25 °C ... +60 °C)
Transport (EN 60721-3-2)			2K3 (temperature: -25 °C ... +70 °C)
Operation (EN 60721-3-3)			3K3 (temperature: -10°C ... +55°C)
Insulation voltage to reference earth/PE			50.0
	U _{AC}	[V]	

Servo Drives 9400 HighLine

Interfaces



EtherNet/IP communication module

Rated data

Product key			E94AYCEN
Communication			
Medium			Twisted Pair, CAT5e to IEEE802.3
Communication profile			GCI, based on TCP/IP
Baud rate			
	b	[MBit/s]	100
Signalling			
			Link Activity
Max. cable length			
between two nodes	l_{max}	[m]	100
Network topology			
			Star Use of hubs/switches
Transmission			
Mode			Half duplex/full duplex
Rated voltage			
	$U_{N,DC}$	[V]	24.0

4.4

Servo Drives 9400 HighLine

Interfaces





POWERLINK communication module

POWERLINK is one of the Ethernet-based bus systems which also uses the tried-and-tested CANopen standards. Each CANopen device profile can also be used directly for EPL without the need to make any adjustments. POWERLINK is suitable for networking between control and inverter, both for pure PLC functionality and for motion control systems. The bus master functionality is performed by the managing node (MN), while the slaves act as controlled nodes (CN).



POWERLINK communication module

4.4

Mode		Features	Slot	Product key
Communication module				
POWERLINK MN/CN		<ul style="list-style-type: none"> • Managing node (MN) or controlled node (CN) • 2 RJ45 connections with LEDs for link and activity • Integrated hub • 2 LEDs for communication status display • External voltage supply possible 	MXI1 MXI2	E94AYCEP
POWERLINK CN		<ul style="list-style-type: none"> • 2 RJ45 connections with LEDs for link and activity • Integrated hub • Controlled node (CN) • 2 LEDs for communication status display • External voltage supply possible 	MXI1 MXI2	E94AYCEC

Standards and operating conditions

Product key			E94AYCEP	E94AYCEC
Mode			POWERLINK MN/CN	POWERLINK CN
Communication module				
Enclosure			IP20	
EN 60529			IP20	
Vibration resistance			Sinusoidal vibration Amplitude/Acceleration Acceleration resistant up to 0.7 g acc. to Germanischer Lloyd 10 Hz ≤ f ≤ 57 Hz: ±0.075 mm amplitude,	
Site altitude			4000	
Amsl	H _{max}	[m]	4000	
Climatic conditions				
Storage (EN 60721-3-1)			1K3 (temperature: -25 °C ... +60 °C)	
Transport (EN 60721-3-2)			2K3 (temperature: -25 °C ... +70 °C)	
Operation (EN 60721-3-3)			3K3 (temperature: -10°C ... +55°C)	
Insulation voltage to reference earth/PE	U _{AC}	[V]	50.0	

Servo Drives 9400 HighLine

Interfaces



POWERLINK communication module

Rated data

Product key			E94AYCEP	E94AYCEC
Communication				
Medium			CAT5e S/FTP according to ISO/ICE11801 (2002)	
Communication profile			EPL2.0	
Baud rate				
	b	[MBit/s]	100	
Node				
			Controlled node (CN) Managing node (MN)	Controlled node (CN)
Network topology				
			Star bei Verwendung von externen Hubs Line bei Verwendung der internen Hubs	
Number of logical process data channels				
Process data words (PZD)				
16 Bit				
Number of bus nodes				
			max. 239	
Max. cable length				
between two nodes	I_{max}	[m]	100	
Rated voltage				
	$U_{N,DC}$	[V]	24.0	

4.4

Ethernet POWERLINK Hub

Lenze offers an external 8-way hub, supplementing the 2-way hub integrated in the Ethernet POWERLINK interface connections. This infrastructure component corresponds to a class-II repeater as per IEEE802.3u. It automatically detects the network baud rate (10 or 100 Mbps). The hubs can be cascaded via a special uplink port.



Ethernet POWERLINK Hub

Mode		Features	Product key
Communication module			
POWERLINK hub		<ul style="list-style-type: none"> DC 24 V Automatic baud rate detection (10/100 Mbps) 8-fold hub in industrial design Cascadable 	E94AZCEH

Servo Drives 9400 HighLine

Interfaces



PROFIBUS communication module

One of the most commonly used industrial communication channels is PROFIBUS. The Servo Drives 9400 range offers the corresponding interface module for this communication.

The PROFIBUS module is a slave connection module with the PROFIBUS-DP communication profile. It is used for networking between control and inverter at fast processing speeds. This allows the inverter to be easily and conveniently integrated into the installation's entire network.



PROFIBUS communication module

4.4

Mode		Features	Slot	Product key
Communication module				
PROFIBUS		<ul style="list-style-type: none"> • Electrical isolation from the bus • 2 LEDs for communication status display • Address can be set via DIP switch • Compatibility switch for communication module EMF2133 IB 	MX11 MX12	E94AYCPM

Standards and operating conditions

Product key			E94AYCPM
Mode			PROFIBUS
Enclosure			IP20
EN 60529			
Vibration resistance			Sinusoidal vibration Amplitude/Acceleration Acceleration resistant up to 0.7 g acc. to Germanischer Lloyd 10 Hz ≤ f ≤ 57 Hz: ±0.075 mm amplitude,
Site altitude			4000
Amsl	H _{max}	[m]	
Climatic conditions			
Storage (EN 60721-3-1)			1K3 (temperature: -25 °C ... +60 °C)
Transport (EN 60721-3-2)			2K3 (temperature: -25 °C ... +70 °C)
Operation (EN 60721-3-3)			3K3 (temperature: -10°C ... +55°C)
Insulation voltage to reference earth/PE			50.0
	U _{AC}	[V]	

Servo Drives 9400 HighLine

Interfaces



PROFIBUS communication module

Rated data

Product key			E94AYCPM
Communication			
Medium			RS 485, shielded twisted pair
Communication profile			PROFIBUS-DP-V1 PROFIBUS-DP-V0 PROFIsafe
Device profile			Lenze device control
Baud rate			
	b	[kBit/s]	9.6 ... 12 000 (automatic detection)
Node			
			Slave
Network topology			
			Line with repeater: Line or tree without repeater:
Process data words (PZD)			
16 Bit			1 ... 32
DP user data length			
			Optional parameter channel (4 words) + process data words
Number of bus nodes			
			31 slaves + 1 master per bus segment With repeaters: 125
Max. cable length			
per bus segment	I_{max}	[m]	1200 (depending on the baud rate and the cable type used)
Rated voltage			
	$U_{N,DC}$	[V]	24.0

Servo Drives 9400 HighLine

Interfaces



PROFINET communication module

The Ethernet-based PROFINET bus system, the successor to PROFIBUS, is often used. There are currently various versions of PROFINET available, which differ with regard to deterministics and thereby also possible cycle times. The most commonly used system is the RT version of PROFINET I/O, which is suitable for networking between control and inverter, although not for motion control applications.



PROFINET communication module

4.4

Mode		Features	Slot	Product key
Communication module				
PROFINET		<ul style="list-style-type: none"> • 2 RJ45 connections with LEDs for link and activity • Integrated 2-port switch • PROFINET I/O device • Soft Real Time (RT) • 2 LEDs for communication status display • External voltage supply possible 	MX11 MX12	E94AYCER

Standards and operating conditions

Product key			E94AYCER
Mode			PROFINET
Enclosure			IP20
EN 60529			
Vibration resistance			Sinusoidal vibration Amplitude/Acceleration Acceleration resistant up to 0.7 g acc. to Germanischer Lloyd 10 Hz ≤ f ≤ 57 Hz: ±0.075 mm amplitude,
Site altitude			4000
Amsl	H _{max}	[m]	
Climatic conditions			
Storage (EN 60721-3-1)			1K3 (temperature: -25 °C ... +60 °C)
Transport (EN 60721-3-2)			2K3 (temperature: -25 °C ... +70 °C)
Operation (EN 60721-3-3)			3K3 (temperature: -10°C ... +55°C)
Insulation voltage to reference earth/PE			50.0
	U _{AC}	[V]	

Servo Drives 9400 HighLine

Interfaces



PROFINET communication module

Rated data

Product key			E94AYCER
Communication			
Medium			CAT5e S/FTP according to ISO/ICE11801 (2002)
Communication profile			PROFINET I/O (RT) PROFIsafe in combination with SM301
Baud rate			
	b	[kBit/s]	100
Node			
			PROFINET I/O device
Network topology			
			Star Use of switches
Process data words (PZD)			
16 Bit			1 ... 32
Max. cable length			
between two nodes	I_{max}	[m]	100
Rated voltage			
	$U_{N,DC}$	[V]	24.0

Servo Drives 9400 HighLine

Accessories



Installation backplane

Up to a rated current of 23.5 A, the Servo Drives 9400 consist of an axis module and an installation backplane. The backplane can initially be mounted in the control cabinet without the axis module. This mechanical structure is also used for power supply modules up to a rated power of 17.5 kW and for regenerative power supply modules for a supply power of up to 27 kW, which simplifies installation. This also offers additional advantages in terms of reduced spare part inventories and time savings in the event of drive replacements. Further features of the installation backplane:

- A brake module for a 24 V DC, 2.5 A brake can be installed as an option
- Shields for power and control cables can be connected

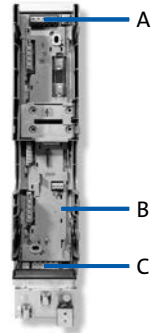

Installation backplane for Single Drive:

- A: mains connection
- B: brake module (optional)
- C: motor connection

Assignment of Single Drive axes and backplanes

Typical motor power	Mains voltage	Product key		Mode
		Single Drive	Installation backplane	
4-pole asynchronous motor				Installation backplane
P	U _{AC}			
[kW]	[V]			
0.37	3 AC 180 ... 550	E94AS□E0024	E94AZPS0034N	Without brake module
			E94AZPS0034H□0051	With brake module
0.75		E94AS□E0034	E94AZPS0034N	Without brake module
			E94AZPS0034H□0051	With brake module
1.50		E94AS□E0044	E94AZPS0074N	Without brake module
			E94AZPS0074H□0051	With brake module
3.00		E94AS□E0074	E94AZPS0074N	Without brake module
			E94AZPS0074H□0051	With brake module
5.50		E94AS□E0134	E94AZPS0244N	Without brake module
			E94AZPS0244H□0051	With brake module
7.50		E94AS□E0174	E94AZPS0244N	Without brake module
			E94AZPS0244H□0051	With brake module
11.0		E94AS□E0244	E94AZPS0244N	Without brake module
			E94AZPS0244H□0051	With brake module

DC busbar set for Single Drive installation backplane

Running the Single Drive axis module in a DC-bus connection (multi-axis application) requires retrofitting the DC busbar system and using DC fuses.

Mechanical coupling is possible with the following components:

- Power supply module
- DC input module
- Single Drive axis modules
- Multi Drive axis modules

For retrofitting the DC busbar system and the DC fuse have to be installed in the axis module's installation backplane, which is provided with the appropriate fixtures.

The DC fuse required is part of the DC busbar set. Spare fuses are not contained in the scope of supply.

Product key		
Installation backplane	DC busbar mounting set	DC fuses
E94AZPS0034N	E94AZJA003	EFSAR0016ARHN
E94AZPS0034H□0051		
E94AZPS0074N	E94AZJA007	EFSAR0040ARHN
E94AZPS0074H□0051		
E94AZPS0244N	E94AZJA024	EFSAR0100ARZN
E94AZPS0244H□0051		

Servo Drives 9400 HighLine

Accessories



Installation backplane

Assignment of Multi Drive axes and backplanes

Typical motor power 4-pole asynchronous motor P [kW]	Mains voltage U_{AC} [V]	Product key		Mode
		Multi Drive	Installation backplane	
0.37	3 AC 180 ... 550	E94AM□E0024	E94AZPM0044N	Without brake module
			E94AZPM0044H□0051	With brake module
E94AM□E0034		E94AZPM0044N	Without brake module	
		E94AZPM0044H□0051	With brake module	
E94AM□E0044		E94AZPM0044N	Without brake module	
		E94AZPM0044H□0051	With brake module	
E94AM□E0074		E94AZPM0094N	Without brake module	
		E94AZPM0094H□0051	With brake module	
E94AM□E0094		E94AZPM0094N	Without brake module	
		E94AZPM0094H□0051	With brake module	
E94AM□E0134		E94AZPM0244N	Without brake module	
		E94AZPM0244H□0051	With brake module	
E94AM□E0174		E94AZPM0244N	Without brake module	
		E94AZPM0244H□0051	With brake module	
E94AM□E0244		E94AZPM0244N	Without brake module	
		E94AZPM0244H□0051	With brake module	
E94AM□E0324	E94AZPM0324N	Without brake module		
	E94AZPM0324H□0051	With brake module		

4.4

Assignment: power supply modules / regenerative power supply modules and mounting backplane

Rated power With mains filter/mains choke P_N [kW]	Mains voltage U_{AC} [V]	Product key		
		Power supply module	Supply- / regenerative module	Installation backplane
4.90 17.5 15.0 27.0	3 AC 180 ... 550	E94APNE0104		E94AZPP0104
		E94APNE0364		E94ARNE0134 E94ARNE0244

Replacement DC fuses for Multi Drive installation backplane

If you need to replace the DC fuse in the Multi Drive installation backplane, the available types are listed in the table below.

Product key	
Installation backplane	DC fuses
E94AZPM0044N	EFSAR0016ARHN
E94AZPM0044H□0051	
E94AZPM0094N	EFSAR0040ARHN
E94AZPM0094H□0051	
E94AZPM0244N	EFSAR0100ARZN
E94AZPM0244H□0051	
E94AZPM0324N	
E94AZPM0324H□0051	

Servo Drives 9400 HighLine

Accessories



Brake modules

Internal activation

An intelligent motor brake logic system is included as standard in the axis modules' device software in the form of a function block.

The brake modules are available in numerous designs.





The optionally integrable brake modules enable a DC 24 V, DC 180 V or DC 205 V brake to be easily connected and this logic to be used.

- For axis modules up to 23.5 A, the brake module is integrated into the installation backplane.
- For axis modules above 32 A, the brake module is integrated into the axis modules.



Brake module, can be integrated into installation backplane

4.4

Mode		Features	Product key
Brake module			
24 V DC/0.3 - 2.5 A		<ul style="list-style-type: none"> • 24 V DC external supply voltage • Monitoring of power supply and brake cable for open circuit and short circuit • Polarity reversal protection for supply voltage • Can be integrated into the installation backplanes, up to 32 A 	E94AZHX0051
24 V DC/1.0 - 5.0 A		<ul style="list-style-type: none"> • 24 V DC external supply voltage • Monitoring of power supply and brake cable for open circuit and short circuit • Polarity reversal protection for supply voltage • Can be integrated into the axis modules, from 32 A 	E94AZHY0101
180 V DC/0.1 - 0.61 A		<ul style="list-style-type: none"> • 400 V AC external supply voltage • Monitoring of power supply and brake cable for open circuit and short circuit • Polarity reversal protection for supply voltage • Can be integrated into the axis modules, from 32 A 	E94AZHY0026
205 V DC/0.1 - 0.75 A		<ul style="list-style-type: none"> • External supply voltage 230 V AC • Monitoring of power supply and brake cable for open circuit and short circuit • Polarity reversal protection for supply voltage • Can be integrated into the axis modules, from 32 A 	E94AZHY0025

External activation

Due to their functional principle, the motor brake in Single Drives cannot be released if there is no mains or DC-bus voltage. Brake modules which can be activated externally are therefore provided for a 24V brake.

Mode	Features	Product key
Brake module		
24 V DC/0.3 - 2.5 A	<ul style="list-style-type: none"> • 24 V DC external supply voltage • Monitoring of power supply and brake cable for open circuit and short circuit • Polarity reversal protection for supply voltage • Can be integrated into the installation backplanes, up to 32 A 	E94AZHA0051
24 V DC/1.0 - 5.0 A	<ul style="list-style-type: none"> • 24 V DC external supply voltage • Monitoring of power supply and brake cable for open circuit and short circuit • Polarity reversal protection for supply voltage • Can be integrated into the axis modules, from 32 A 	E94AZHB0101

Servo Drives 9400 HighLine



Accessories



Brake modules

External brake modules

The external brake modules are provided for DIN rail installation and can be used if axis modules up to 23.5A require brake voltages of 180V DC and 205V DC.

Mode		Features	Product key
Brake module			
180 V DC/0.1 - 0.75 A		<ul style="list-style-type: none">• 400 V AC external supply voltage• Monitoring of power supply and brake cable for open circuit and short circuit• Polarity reversal protection for supply voltage• Preconfigured for DIN rail mounting	E94AZHN0026
205 V DC/0.1 - 0.75 A		<ul style="list-style-type: none">• External supply voltage 230 V AC• Monitoring of power supply and brake cable for open circuit and short circuit• Polarity reversal protection for supply voltage• Preconfigured for DIN rail mounting	E94AZHN0025

Servo Drives 9400 HighLine

Accessories



Brake resistors

The assignment of brake resistors to Single Drive axis modules is shown in the table below.

- Two resistors should be connected in parallel for the following combinations:
 E94AS□E3664 and ERBG035D03K3
 E94AS□E4604 and ERBG028D04K1
 E94AS□E5724 and ERBG023D05K6
 E94AS□E6354 and ERBG023D05K6
 E94AS□E6954 and ERBG023D05K6



3.5 ohm brake resistor

Typical motor power	Mains voltage	Product key		Rated resistance	Rated power	Thermal capacity	Dimensions	Mass
		Single Drive	Brake resistor					
4-pole asynchronous motor								
P	U _{AC}			R _N	P _N	C _{th}	h x b x t	m
[kW]	[V]			[Ω]	[kW]	[kW _s]	[mm]	[kg]
45.0	3 AC 180 ... 550 ¹⁾	E94AS□E0864	ERBG075D01K9	7.5	1900.0	285	486 x 236 x 302	9.5
55.0		E94AS□E1044						
75.0	3 AC 342 ... 550	E94AS□E1454	ERBG005R02K6	5.0	2600.0	390	486 x 326 x 302	12.6
90.0		E94AS□E1724	ERBG043D03K0	4.3	3000.0	450		11.8
105		E94AS□E2024	ERBG035D03K3	3.5	3300.0	495		12.6
130		E94AS□E2454	ERBG028D04K1	2.8	4100.0	615	486 x 426 x 302	12.8
150		E94AS□E2924	ERBG023D05K6	2.3	5600.0	840		15.9
190		E94AS□E3664	ERBG035D03K3	3.5	3300.0	495	486 x 326 x 302	12.6
240		E94AS□E4604	ERBG028D04K1	2.8	4100.0	615	486 x 426 x 302	12.8
300		E94AS□E5724	ERBG023D05K6	2.3	5600.0	840		15.9
335		E94AS□E6354						
370		E94AS□E6954						

¹⁾ For 230 V mains voltage a different brake resistor assignment applies.

 Data sheet on brake resistors
 DS_9400_0002
 Available for download at www.lenze.de/dsc

Servo Drives 9400 HighLine

Accessories



Mains chokes

A mains choke is an inductive resistor which is connected in the mains cable of the power supply module. The use of a mains choke provides the following advantages:

- **Fewer effects on the mains:**
The wave form of the mains current is a close approximation to a sine wave.
- **Reduction in the effective mains current:**
Reduction of mains, cable and fuse loads

Mains chokes can be used without restrictions in conjunction with RFI filters and/or sinusoidal filters.

Please note:

: The use of a mains choke slightly reduces the mains voltage at the input of the inverter - the typical voltage drop across the mains choke at the rated values is around 5%.



Mains choke

Typical motor power	Mains voltage	Product key		Rated current	Dimensions	Mass
		Single Drive	Mains choke			
4-pole asynchronous motor						
P	U_{AC}			I_N	$h \times b \times t$	m
[kW]	[V]			[A]	[mm]	[kg]
0.37	3 AC 180 ... 550	E94AS□E0024	EZAELN3002B153	2.00	56 x 77 x 100	0.5
0.75		E94AS□E0034	EZAELN3004B732	4.00	60 x 95 x 114	1.3
1.50		E94AS□E0044	EZAELN3006B492	6.00	69 x 95 x 117	1.5
3.00		E94AS□E0074	EZAELN3010B292	10.0	85 x 120 x 134	2.0
5.50		E94AS□E0134	EZAELN3020B152	20.0	95 x 155 x 162	3.8
7.50		E94AS□E0174	EZAELN3025B122	25.0	110 x 155 x 167	5.8
11.0		E94AS□E0244	EZAELN3035B841	35.0		6.0

- The mains choke is integrated in the Single Drives as of a 32 A rated current.

Servo Drives 9400 HighLine

Accessories



Servo Drives 9400 HighLine

Accessories



RFI and mains filters

RFI filters and mains filters enable compliance with the interference voltage categories of the European standard EN 61800-3. There a distinction is drawn between category C1 and category C2.

Category C1 describes the use on public supply networks.

Category C2 describes the use of drives which are intended to be used for industrial purposes in areas also comprising residential areas.



RFI filter, can be mounted beside or below the axis module

RFI filters

4.4

RFI filters are capacitive accessory components which can be connected directly upstream of the axis modules. This measure enables compliance with the corresponding conducted noise emission requirements according to EN61800-3.

Typical motor power	Mains voltage	Product key		Rated current	Power loss	Max. cable length		Dimensions	Mass
		Single Drive	RFI filter			shielded C1 with external measures	shielded C2 with external measures		
P	U _{AC}			I _N	P _V	I _{max}	I _{max}	h x b x t	m
[kW]	[V]			[A]	[kW]	[m]	[m]	[mm]	[kg]
0.37	3 AC 180 ... 550	E94AS□E0024	E94AZRS0044	3.50	4.00	0	50	522 x 60 x 60	1.8
0.75		E94AS□E0034							
1.50		E94AS□E0044	E94AZRS0104	10.0	8.00			522 x 90 x 60	2.3
3.00		E94AS□E0074							
5.50		E94AS□E0134	E94AZRS0294	29.0	22.0			522 x 120 x 60	3.6
7.50		E94AS□E0174							
11.0		E94AS□E0244							
15.0		E94AS□E0324	E94AZRS0544	54.0	50.0	670 x 201 x 60	9.0		
22.0		E94AS□E0474							
30.0		E94AS□E0594							
45.0		E94AS□E0864	E94AZRS0954	95.0	70.0	780 x 261 x 60	13.0		
55.0		E94AS□E1044							

▶ Data sheet on RFI filters
DS_9400_0003

Available for download at www.lenze.com/dsc

Servo Drives 9400 HighLine

Accessories



RFI and mains filters

Mains filters

A mains filter is a combination of mains choke and RFI filter in a single housing. It reduces line-bound noise emission into the mains, thus ensuring that the line-bound interference voltage is reduced to a permissible level according to EN61800-3.



Mains filter, can be mounted beside or below the axis module

4.4

Typical motor power	Mains voltage	Product key		Rated current	Voltage drop	Max. cable length		Dimensions	Mass
		Single Drive	Mains filter			shielded C1 with external measures	shielded C2 with external measures		
4-pole asynchronous motor									
P	U_{AC}			I_N	U	I_{max}	I_{max}	h x b x t	m
[kW]	[V]			[A]	[V]	[m]	[m]	[mm]	[kg]
0.37	3 AC 180 ... 550	E94AS□E0024	E94AZMS0034	3.20	10.0	25	50	522 x 60 x 60	3.3
0.75		E94AS□E0034							
1.50		E94AS□E0044	E94AZMS0094	9.00			100	522 x 90 x 60	3.9
3.00		E94AS□E0074							
5.50		E94AS□E0134	E94AZMS0184	18.0			7.4	522 x 120 x 60	8.4
7.50		E94AS□E0174							
11.0		E94AS□E0244	E94AZMS0314	31.0			7.3		8.8

▶ Data sheet on mains filters
DS_9400_0004
 Available for download at www.lenze.de/dsc

Servo Drives 9400 HighLine

Accessories



Sinusoidal filters

A sinusoidal filter in the motor cable limits the rate of voltage rise and the capacitive charge/discharge currents that occur during inverter operation. In combination with the specified line filter, the EMC requirements of the limit class C2 for conducted noise emissions are still met, even if longer shielded or even unshielded motor cables are used.

Application range:

- Only use a sinusoidal filter with standard 0 to 550 V asynchronous motors
- Operation only with V/f or V/f² characteristic control
- Set the switching frequency permanently to the specified value
- Limit the output frequency of the Servo Drives 9400 to the specified value



Sinusoidal filter

Typical motor power	Mains voltage	Product key			Max. output frequency	Rated inductance	Switching frequency	Mass
		Single Drive	RFI filter	Mains filter				
4-pole asynchronous motor								
P	U _{AC}				f _{max, 2}	L _N	f _{ch}	m
[kW]	[V]				[Hz]	[mH]	[kHz]	[kg]
0.37	3 AC 180 ... 550	E94AS□E0024		E94AZMS0034		11.0	4 8	4.0
0.75		E94AS□E0034						
1.50		E94AS□E0044		E94AZMS0094		5.10		5.5
3.00		E94AS□E0074						
5.50		E94AS□E0134		E94AZMS0184		2.50		14.5
7.50		E94AS□E0174						
11.0		E94AS□E0244		E94AZMS0314		1.70		21.0
15.0		E94AS□E0324				1.20		25.5
22.0		E94AS□E0474		E94AZRS0544		1.00		33.5
30.0		E94AS□E0594				0.95		37.0
45.0		E94AS□E0864	E94AZRS0954	0.70	66.0			
55.0		E94AS□E1044		0.50	69.0			

 Data sheet on sinusoidal filters
DS_ZB_EZS3_0001
 Available for download at www.lenze.de/dsc

Servo Drives 9400 HighLine

Accessories



Sinusoidal filters

Typical motor power	Mains voltage	Product key		Max. output frequency	Rated inductance	Switching frequency	Mass
4-pole asynchronous motor		Single Drive	Sinusoidal filter				
P	U _{AC}			f _{max, 2}	L _N	f _{ch}	m
[kW]	[V]			[Hz]	[mH]	[kHz]	[kg]
75.0	3 AC 342 ... 550	E94AS□E1454	EZS3-180A200 ³⁾		0.40	2 4	95.0
90.0		E94AS□E1724	EZS3-250A200 ³⁾		0.35		107.0
105		E94AS□E2024					109.0
130		E94AS□E2454	EZS3-350A200 ³⁾		0.21		132.0
150		E94AS□E2924			0.14		161.0
190		E94AS□E3664	EZS3-480A200 ³⁾		0.21		266.0
240		E94AS□E4604 ¹⁾	EZS3-350A200 ³⁾				278.0
300		E94AS□E5724 ¹⁾	EZS3-480A200 ³⁾		0.14		300.0
335		E94AS□E6354 ¹⁾					321.0
370		E94AS□E6954 ²⁾	EZS3-350A200 ³⁾		0.21		

¹⁾ Two sinusoidal filters must be connected in parallel

²⁾ Three sinusoidal filters must be connected in parallel

³⁾ If the parameters for devices over 75 kW/145 A are set for operation with "increased rated output current" (code C01199), different assignments may be necessary.

 Data sheet on sinusoidal filters

DS_ZB_EZS3_0001

Available for download at www.lenze.de/dsc





Servo Drives 9400 HighLine

Accessories



Rated data for power supply modules

► The data is valid for operation at 3/PE AC 400 V.

						
Product key						
Power supply module			E94APNE0104	E94APNE0364	E94APNE1004	E94APNE2454
Rated power						
With mains filter/mains choke	P_N	[kW]	4.90	17.5	48.6	119
Without mains filter/mains choke	P_N	[kW]	3.60	13.0	36.2	88.6
Mains voltage range			3/PE AC 180 V-0 % ... 550 V+0 %, 45 Hz-0 % ... 65 Hz+0 %			
Rated mains current						
	$I_{N,AC}$	[A]	8.0	29.0	82.0	200.0
Rated DC-bus current						
	$I_{N,DC}$	[A]	10.0	36.0	100.0	245.0

4.4

Data for 60 s overload

Max. DC-bus current						
	I_{max}	[A]	15.0	54.0	150.0	368.0
Reduced DC-bus current						
	$I_{red,DC}$	[A]	7.5	27.0	75.0	183.5
Overload time						
	t_{ol}	[s]	120.0			
Recovery time						
	t_{re}	[s]	60.0			
Max. output power¹⁾						
	$P_{max,1}$	[kW]	7.4	26.3	72.9	179.0

Data for 0.5 s overload

Max. short-time DC-bus current						
	I_{max}	[A]	40.0	108.0	200.0	368.0
Reduced DC-bus current						
	$I_{red,DC}$	[A]	7.5	27.0	75.0	183.5
Overload time						
	t_{ol}	[s]	0.5			
Recovery time						
	t_{re}	[s]	4.5			
Max. short-time output power¹⁾						
	$P_{max,2}$	[kW]	19.6	52.5	146.0	357.0

¹⁾ Mains filter required; if no mains filter is installed, the stated values for P_{max} decrease





Servo Drives 9400 HighLine

Accessories



Rated data for power supply modules

► The data is valid for operation at 3/PE AC 400 V.

						
Product key						
Power supply module			E94APNE0104	E94APNE0364	E94APNE1004	E94APNE2454
Rated power						
With mains filter/mains choke	P_N	[kW]	4.90	17.5	48.6	119
Without mains filter/mains choke	P_N	[kW]	3.60	13.0	36.2	88.6
Rated DC-bus current						
	$I_{N,DC}$	[A]	10.0	36.0	100.0	245.0
Power loss						
	P_V	[W]	55.0	110	230	550
Dimensions						
Height	h	[mm]	350			383
Height, including fastening	h	[mm]	481			510
Width	b	[mm]	60	120	210	390
Depth	t	[mm]	288			
Mass						
	m	[kg]	2.6	5.3	13.5	28.5

4.4

Brake chopper rated data

Rated power, Brake chopper						
	P_N	[kW]	2.6	8.7	17.0	30.3
Max. output power, Brake chopper						
	$P_{max,1}$	[kW]	19.5	43.8	105.1	187.7
Running time						
	t_{on}	[s]	1.0			
Recovery time						
	t_{re}	[s]	3.8	2.5	3.1	
Min. brake resistance						
	R_{min}	[Ω]	27.0	12.0	5.0	2.8

Servo Drives 9400 HighLine

Accessories



Rated data for regenerative power supply modules

- ▶ The data is valid for operation at 3/PE AC 400 V.
- ▶ Mains filter required, please refer to the following pages

						
Product key			E94ARNE0134		E94ARNE0244	
Supply- / regenerative module						
Operating mode			Feed	Feedback	Feed	Feedback
Rated power						
With mains filter/mains choke	P_N	[kW]	15.0	7.50	27.0	13.5
Mains voltage range			3/PE AC 180 V-0 % ... 550 V+0 %, 45 Hz-0 % ... 65 Hz+0 %			
	U_{AC}	[V]				
Rated mains current						
	$I_{N, AC}$	[A]	26.0	13.0	47.0	23.5
Rated DC-bus current						
	$I_{N, DC}$	[A]	32.0	16.0	57.0	29.0

Data for 60 s overload

Max. DC-bus current						
	I_{max}	[A]	48.0	24.0	86.0	44.0
Reduced DC-bus current						
	$I_{red, DC}$	[A]	20.0	9.8	35.0	18.0
Overload time			60.0			
	t_{ol}	[s]				
Recovery time			120.0			
	t_{re}	[s]				
Max. output power						
	$P_{max, 1}$	[kW]	22.4	11.2	40.5	20.2

Data for 0.5 s overload

Max. short-time DC-bus current						
	I_{max}	[A]	96.0	48.0	171.0	87.0
Reduced DC-bus current						
	$I_{red, DC}$	[A]	20.0	9.8	35.0	18.0
Max. short-time output power						
	$P_{max, 2}$	[kW]	44.9	22.4	81.1	40.5
with brake chopper support	$P_{max, 2}$	[kW]		35.1		59.6

Servo Drives 9400 HighLine

Accessories



Rated data for regenerative power supply modules

- ▶ The data is valid for operation at 3/PE AC 400 V.
- ▶ Mains filter required, please refer to the following pages

						
Product key			E94ARNE0134		E94ARNE0244	
Supply- / regenerative module						
Operating mode			Feed	Feedback	Feed	Feedback
Rated power						
With mains filter/mains choke	P_N	[kW]	15.0	7.50	27.0	13.5
Rated DC-bus current						
	$I_{N,DC}$	[A]	32.0	16.0	57.0	29.0
Power loss						
	P_V	[W]	150	110	230	190
Dimensions						
Height	h	[mm]	350			
Height, including fastening	h	[mm]	481			
Width	b	[mm]	120			
Depth	t	[mm]	288			
Mass						
	m	[kg]	6.0			

4.4

Brake chopper rated data

Rated power, Brake chopper				
	P_N	[kW]	4.7	9.3
Max. output power, Brake chopper				
	$P_{max,1}$	[kW]	19.5	29.2
Running time				
	t_{on}	[s]	1.0	
Recovery time				
	t_{re}	[s]	4.2	3.9
Min. brake resistance				
	R_{min}	[Ω]	27.0	18.0

Servo Drives 9400 HighLine

Accessories



Control connections

Mode	Power supply modules	Regenerative power supply modules
Analog inputs		
Number		2
Resolution		11 bits + sign
Value range		+/- 10V 1 x switchable 20 mA
Analog outputs		
Number		2
Resolution		10 bits + sign
Value range		+/- 10V max. 2 mA
Digital inputs		
Number	1 Permanently configured	8
Switching level	PLC (IEC 61131-2)	
Max. input current	8 mA	
Digital outputs		
Number	4 fest konfiguriert	4
Switching level	PLC (IEC 61131-2)	
Max. output current	50 mA per output	
Load capacity	>480 Ω at 24 V	
External DC supply		
Rated voltage	24 V in accordance with IEC 61131-2	
Voltage range	19.2 ... 28.8 V, max. residual ripple ± 5%	
Current	Approx. 1.4 A during operation, max. 4 A starting current for 100 ms	Approx. 1.2 A during operation, max. 3 A starting current for 100 ms ¹⁾
Interfaces		
CANopen		Integrated
Extensions		Via slot MXI 2: extension 2 Via slot MXI 1: extension 1
State bus		Integrated
Memory		Slot MMI
Safety engineering		Slot MSI
Drive interface		
Resolver input		Integrated (no function)
Mains synchronisation input		Integrated Sub-D, 15-pin

¹⁾ The supply to the control electronics comes from the mains voltage. Alternatively, it can be provided by a 24 V supply that is independent of the mains (available as an option).

Servo Drives 9400 HighLine

Accessories



Brake resistors of the regenerative power supply modules

Assignment of brake resistors to the supply and regenerative power supply modules is shown in the tables below.



Brake resistor 27 ohms

Brake resistors for power supply modules

Rated power	Mains voltage	Product key		Rated resistance	Rated power	Thermal capacity	Dimensions	Mass
Without mains filter/mains choke		Power supply module	Brake resistor					
P_N	U_{AC}			R_N	P_N	C_{th}	$h \times b \times t$	m
[kW]	[V]			[Ω]	[kW]	[KWs]	[mm]	[kg]
3.60	3 AC 180 ... 550 ¹⁾	E94APNE0104	ERBP027R200W	27.0	200.0	30.0	320 x 41 x 122	1.0
			ERBS027R600W		600.0	90.0	550 x 110 x 105	3.1
			ERBS027R01K2		1200.0	180	1020 x 110 x 105	5.6
13.0		E94APNE0364	ERBG012R01K9	12.0	1900.0	285	486 x 236 x 302	13.0
			ERBG012R05K2		5200.0	750	486 x 426 x 302	28.0
36.2		E94APNE1004	ERBG005R02K6	5.0	2600.0	390	486 x 326 x 302	12.6
88.6		E94APNE2454	ERBG028D04K1	2.8	4100.0	615	486 x 426 x 302	12.8

¹⁾ For 230 V mains voltage a different brake resistor assignment applies.

Brake resistors for regenerative power supply modules

Rated power	Mains voltage	Product key		Rated resistance	Rated power	Thermal capacity	Dimensions	Mass
With mains filter/mains choke		Supply- / regenerative module	Brake resistor					
P_N	U_{AC}			R_N	P_N	C_{th}	$h \times b \times t$	m
[kW]	[V]			[Ω]	[kW]	[KWs]	[mm]	[kg]
15.0	3 AC 180 ... 550 ²⁾	E94ARNE0134	ERBP027R200W	27.0	200.0	30.0	320 x 41 x 122	1.0
			ERBS027R600W		600.0	90.0	550 x 110 x 105	3.1
			ERBS027R01K2		1200.0	180	1020 x 110 x 105	5.6
27.0		E94ARNE0244	ERBP018R300W	18.0	300.0	30.0	240 x 41 x 122	1.4
			ERBS018R01K2		1200.0	180	1020 x 110 x 105	5.6
			ERBS018R02K8		2800.0	420	1110 x 200 x 105	12.0

²⁾ For 230 V mains voltage a different brake resistor assignment applies.

 Data sheet on brake resistors
DS_9400_0002
 Available for download at www.lenze.de/dsc

Servo Drives 9400 HighLine

Accessories



Interference suppression of the regenerative power supply modules

RFI filters and mains filters enable compliance with the interference voltage categories of the European standard EN 61800-3. There a distinction is drawn between category C1 and category C2.

Category C1 describes the use on public supply networks.

Category C2 describes the use of drives which are intended to be used for industrial purposes in areas also comprising residential areas.

For Multi Drives external filters must be used to comply with the EMC Directive.



RFI filter, can be mounted beside the power supply module

RFI filters

4.4

RFI filters are primarily capacitive accessory components which can be connected directly upstream from the power supply modules. This measure enables compliance with the corresponding conducted noise emission requirements according to EN 61800-3.

Rated power	Mains voltage	Product key		Rated current	Power loss	Max. cable length	Dimensions	Mass
		Power supply module	RFI filter					
Without mains filter/mains choke						Reference group C2		
P_N	U_{AC}			I_N	P_V	l_{max}	$h \times b \times t$	m
[kW]	[V]			[A]	[kW]	[m]	[mm]	[kg]
3.60	3 AC 180 ... 550	E94APNE0104	E94AZRP0084	8.00	20.0	6 axes of 10 m each	485 x 60 x 261	4.2
13.0		E94APNE0364	E94AZRP0294	29.0	50.0			4.5
36.2		E94APNE1004	E94AZRP0824	82.0	80.0		490 x 209 x 272	18.5
88.6		E94APNE2454	E94AZRP2004	200	150			20.5

▶ Data sheet on RFI filters
DS_9400_0003

Available for download at www.lenze.com/dsc



Interference suppression of the regenerative power supply modules

Mains filters

A mains filter is a combination of mains choke and RFI filter in a single housing. It reduces line-bound noise emission into the mains, thus ensuring that the line-bound interference voltage is reduced to a permissible level according to EN61800-3.



Mains filter, can be mounted beside the power supply modules (right) or the regenerative power supply modules (left)

Mains filters for power supply modules

Rated power	Mains voltage	Product key		Rated current	Voltage drop	Max. cable length	Dimensions	Mass
		Power supply module	Mains filter					
With mains filter/mains choke						Reference group C2		
P_N	U_{AC}			I_N	U	I_{max}	$h \times b \times t$	m
[kW]	[V]			[A]	[V]	[m]	[mm]	[kg]
4.90	3 AC 180 ... 550	E94APNE0104	E94AZMP0084	8.00	10.0	10 axes of 50 m each	485 x 90 x 261	8.6
17.5		E94APNE0364	E94AZMP0294	29.0	7.3		485 x 120 x 261	16.5
48.6		E94APNE1004	E94AZMP0824 ¹⁾	82.0	6.4		490 x 270 x 272	29.0
119		E94APNE2454	E94AZMP2004 ¹⁾	200	6.3		490 x 330 x 272	52.0

¹⁾ External 24 V supply from a safely separated power supply unit (SELV/PELV) required for integrated fan.

Mains filters for regenerative power supply modules

Rated power	Mains voltage	Product key		Rated current	Voltage drop	Max. cable length	Dimensions	Mass
		Supply- / regenerative module	Mains filter					
With mains filter/mains choke						Reference group C2		
P_N	U_{AC}			I_N	U	I_{max}	$h \times b \times t$	m
[kW]	[V]			[A]	[V]	[m]	[mm]	[kg]
15.0	3 AC 180 ... 550	E94ARNE0134	E94AZMR0264SDB ²⁾	26.0	6.3	6 axes of 10 m each	485 x 149 x 272	25.0
			E94AZMR0264LDB ²⁾			10 axes of 50 m each		26.0
27.0		E94ARNE0244	E94AZMR0474SDB ²⁾	47.0	6.2	6 axes of 10 m each	485 x 209 x 272	36.0
			E94AZMR0474LDB ²⁾			10 axes of 50 m each		37.0

²⁾ External 24 V supply through safely separated power supply unit (SELV/PELV) required for integrated mains voltage recording.

Data sheet on mains filters
DS_9400_0004
 Available for download at www.lenze.de/dsc

Servo Drives 9400 HighLine

Accessories



DC input module

Via a DC input module, an axis module interconnection can be supplied with power from a central DC source (power supply module, Single Drive axis modules, Multi Drive axis modules). This is required for example if a drive system with a multi-level structure installed in a control cabinet is to be supplied via a central DC power supply unit. The rated current of the DC input module is defined to be 100 A (DC). The DC input module can be connected at the top or bottom, offering great flexibility with regard to integration into the system wiring. This provides an ideal way of connecting multi-row axis modules in particular.



DC input module
100 A

4.4

Mode	Product key	Dimensions	Mass
	Input module		
		h x b x t	m
		[mm]	[kg]
DC input module 100 A	E94AZEX100	422 x 60 x 95	0.9

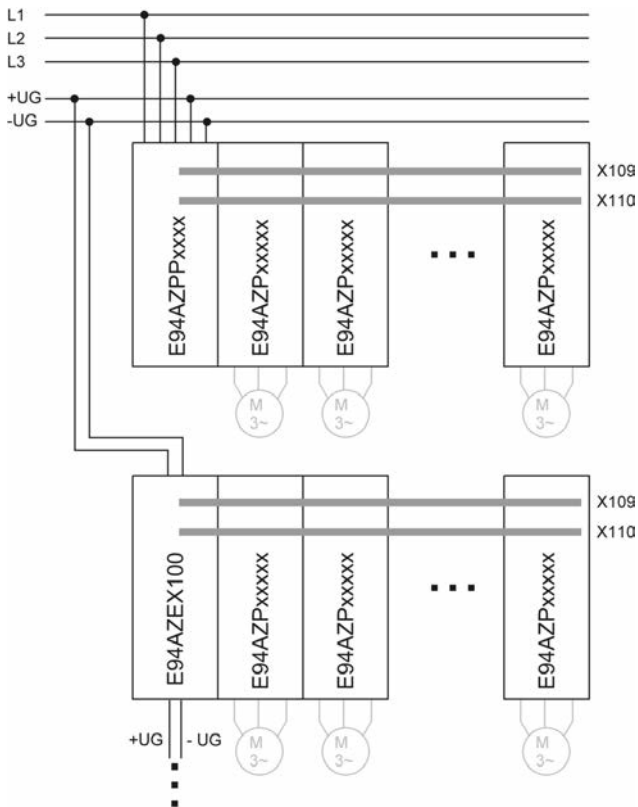

Wiring example for multi-row mounting of axis modules

Servo Drives 9400 HighLine

Accessories



DC-bus connection

The Servo Drives 9400 HighLine can be operated in a DC-bus connection. The 400 V devices have a direct connection for this.

The components listed here are used to interconnect the individual devices for operation with or without a regenerative power supply module. With a DC-bus connection, energy can be exchanged between the individual devices. This makes particular sense with cyclic operation of multiple devices.

The design of a DC-bus connection requires extremely precise dimensioning of the devices' energy requirements among one another. Lenze Sales is happy to advise you here to ensure the most energy-efficient drive dimensioning. The components listed here form the basis for this.

- ▶ Two DC fuses are always required.
- ▶ The fuse holders EFH10005 and EFH10004 are single-pole, while the holders EFH20005 and EFH20007 are 2-pole.
- ▶ The DC fuses are not UL-approved
- ▶ Please consult Lenze Sales to ensure the right dimensioning.

Components for DC-bus connection

Product key	Rated current	Design
DC fuses		
	I_N	
	[A]	
EFSGR0060AYHN	6.00	14x51 without indicator
EFSGR0100AYHN	10.0	
EFSGR0160AYHN	16.0	
EFSGR0200AYHN	20.0	
EFSGR0250AYHN	25.0	
EFSGR0320AYHN	32.0	
EFSGR0400AYHN	40.0	
EFSGR0060AYHK	6.00	14x51 with indicator
EFSGR0100AYHK	10.0	
EFSGR0160AYHK	16.0	
EFSGR0200AYHK	20.0	
EFSGR0250AYHK	25.0	
EFSGR0320AYHK	32.0	
EFSGR0400AYHK	40.0	
EFSGR1000ANVN	100	NH1
EFSGR2000ANVN	200	
EFSGR2500ANVN	250	
EFSGR3500ANVN	350	NH2
EFSGR4000ANVN	400	
EFSGR5000ANVN	500	

Product key	Rated current	Design
DC fuses		
	I_N	
	[A]	
EFSGR0120AYIN	12.0	22x58 without indicator
EFSGR0160AYIN	16.0	
EFSGR0200AYIN	20.0	
EFSGR0250AYIN	25.0	
EFSGR0320AYIN	32.0	
EFSGR0400AYIN	40.0	
EFSGR0500AYIN	50.0	
EFSGR0630AYIN	63.0	22x58 with indicator
EFSGR0800AYIN	80.0	
EFSGR1000AYIN	100	
EFSGR0120AYIK	12.0	
EFSGR0160AYIK	16.0	
EFSGR0200AYIK	20.0	
EFSGR0250AYIK	25.0	
EFSGR0320AYIK	32.0	
EFSGR0400AYIK	40.0	
EFSGR0500AYIK	50.0	
EFSGR0630AYIK	63.0	
EFSGR0800AYIK	80.0	
EFSGR1000AYIK	100	

Mode	Features	Product key
DC busbar	<ul style="list-style-type: none"> • Busbar system 14 x 51 • DC busbar length 1m, cross-section 25 mm² 	EWZ0036
	<ul style="list-style-type: none"> • Busbar system 22 x 58 • DC busbar length 1m, cross-section 25 mm² 	EWZ0037
End cap	<ul style="list-style-type: none"> • End caps for DC busbar (packaging unit 10 pcs) 	EWZ0038
Terminal	<ul style="list-style-type: none"> • Single-pole terminal for internal supply 	EWZ0039

Servo Drives 9400 HighLine

Accessories



DC-bus connection

DC fuses size 14 x 51 mm

Typical motor power 4-pole asynchronous motor	Mains voltage U_{AC}	Product key						
		Single Drive	Multi Drive	DC fuses				
P [kW]	[V]							
0.37	3 AC 180... 550	E94AS□E0024		EFSGR0200AYHN	EFH20005	EFSGR0200AYHK	EFH10005	
			E94AM□E0024					
0.75		E94AS□E0034						
			E94AM□E0034					
1.50		E94AS□E0044		EFSGR0320AYHN				EFSGR0320AYHK
			E94AM□E0044	EFSGR0200AYHN				EFSGR0200AYHK
3.00		E94AS□E0074		EFSGR0320AYHN				EFSGR0320AYHK
			E94AM□E0074					
4.00			E94AM□E0094					

4.4

DC fuses size 22 x 58 mm

Typical motor power 4-pole asynchronous motor	Mains voltage U_{AC}	Product key						
		Single Drive	Multi Drive	DC fuses				
P [kW]	[V]							
0.37	3 AC 180... 550	E94AS□E0024		EFSGR0200AYIN	EFH20007	EFSGR0200AYIK	EFH10004	
			E94AM□E0024					
0.75		E94AS□E0034						
			E94AM□E0034					
1.50		E94AS□E0044		EFSGR0320AYIN				EFSGR0320AYIK
			E94AM□E0044	EFSGR0200AYIN				EFSGR0200AYIK
3.00		E94AS□E0074		EFSGR0320AYIN				EFSGR0320AYIK
			E94AM□E0074					
4.00			E94AM□E0094					
		5.50	E94AS□E0134			EFSGR0630AYIN		EFSGR0630AYIK
			E94AM□E0134					
7.50		E94AS□E0174						
			E94AM□E0174					
11.0		E94AS□E0244		EFSGR1000AYIN		EFSGR1000AYIK		
			E94AM□E0244					
15.0		E94AS□E0324						
		E94AM□E0324						
22.0	E94AS□E0474							

Servo Drives 9400 HighLine

Accessories



DC-bus connection

NH1 and NH2 DC fuses

Typical motor power 4-pole asynchronous motor	Mains voltage U_{AC}	Product key					
		Single Drive	Multi Drive	DC fuses			
P [kW]	U_{AC} [V]						
11.0	3 AC 180 ... 550	E94AS□E0244		EFSGR1000ANVN			
15.0		E94AS□E0324					
22.0		E94AS□E0474					
30.0		E94AS□E0594					
45.0		E94AS□E0864					
55.0		E94AS□E1044					
75.0	3 AC 342 ... 550	E94AS□E1454		EFSGR2000ANVN			
90.0		E94AS□E1724		EFSGR2500ANVN			
105		E94AS□E2024		EFSGR3500ANVN			
130		E94AS□E2454		EFSGR4000ANVN			
150		E94AS□E2924		EFSGR5000ANVN			
190		E94AS□E3664		EFSGR3500ANVN			
240		E94AS□E4604		EFSGR4000ANVN			
300		E94AS□E5724		EFSGR5000ANVN			
335		E94AS□E6354		EFSGR4000ANVN			
370		E94AS□E6954		EFSGR5000ANVN			

4.4

- ▶ Two DC fuses must be connected in parallel on the E94AS□E2924, E94AS□E3664, E94AS□E4604 inverters.
- ▶ Three DC fuses must be connected in parallel on the E94AS□E5724, E94AS□E6354, E94AS□E6954 inverters.

Servo Drives 9400 HighLine

Accessories



24 V power supply unit

Multi-axis applications with Multi Drive axis modules require an external power supply unit to feed the control electronics. Depending on the number of axis modules, power supply units with a rated current of 5, 10 or 20 A can be selected with a voltage supply of 1 x 230 V AC or 3 x 400 V AC.

Single Drive axis modules generally do not require the use of the power supply unit. If, however, separate power supplies are needed for the control electronics and power section in a single-axis application, the same power supply units can be used.



24 V power supply unit

Rated data

Product key			EZV1200-000	EZV2400-000	EZV4800-000	EZV1200-001	EZV2400-001	EZV4800-001
Rated voltage			230			400		
	$U_{N, AC}$	[V]	230			400		
Rated mains current			0.8	1.2	2.3	0.3	0.6	1.0
	$I_{N, AC}$	[A]	0.8	1.2	2.3	0.3	0.6	1.0
Output voltage			DC 22.5 ...28.5					
	U_{out}	[V]	DC 22.5 ...28.5					
Rated current			5.00	10.0	20.0	5.00	10.0	20.0
	I_N	[A]	5.00	10.0	20.0	5.00	10.0	20.0
Dimensions								
Height	h	[mm]	130					
Width	b	[mm]	55	85	157	73	85	160
Depth	t	[mm]	125					
Mass								
	m	[kg]	0.8	1.2	2.5	1.0	1.1	1.9

4.4

CAN bus connector

The connector is used to connect the CAN to inverters which are provided with a Sub-D connection for the CAN bus. An integrated CAN terminating resistor can be switched on/off. Internal spring terminals make the use of special mounting tools superfluous. The switch setting can be read from two sides.



CAN bus connector

Mode	Product key
CAN bus connector: Switch	EWZ0046

Servo Drives 9400 HighLine

Accessories



USB diagnostic adapter

The operation, parameter setting and diagnostics of the Inverter Drives 8400 and the Servo Drives 9400 via the L-force diagnostics is made with the keypad X400 or a PC. The connection of a PC can be made via a USB interface and the USB diagnostic adapter.

For connecting the USB diagnostic adapter with the L-force diagnostics interface (DIAG) at the inverter, three different connecting cables are separately available in the lengths 2.5 m, 5 m and 10 m. The connection can be established during operation. The engineering tools EASY Starter or Engineer can be used to carry out the operation, parameter setting or diagnostics of the inverters. Both tools have simple intuitive surfaces. This enables a quick and easy commissioning.

Optionally to the USB diagnostic adapter, the PC system bus adapter can be used. For this purpose, a CANopen interface must be available at the inverter.



USB diagnostic adapter incl. connecting cable to the PC

- The engineering tools EASY Starter or Engineer are used for operation, parameter setting and diagnostics of the inverters.

Mode		Features	Product key
USB diagnostic adapter		<ul style="list-style-type: none"> • Input-side voltage supply via USB connection on PC • Output-side voltage supply via inverter's diagnostic interface • Diagnostic LEDs • Electrical isolation of PC and inverter • Hot-pluggable 	E94AZCUS

Connecting cables for USB diagnostic adapter

Mode	Features	Product key
Connecting cable for USB diagnostic adapter	• Length: 2.5 m	EWL0070
	• Length: 5 m	EWL0071
	• Length: 10 m	EWL0072

Servo Drives 9400 HighLine

Accessories



X400 keypad

As an alternative to the PC, the X400 keypad can be used for local operation, parameter setting or diagnostics. The X400 keypad plugs into the L-force diagnostics interface (DIAG) on the front of the inverter.



X400 keypad

Mode		Features	Slot	Product key
X400 keypad		<ul style="list-style-type: none"> • Menu navigation • Graphics display with background lighting for clear presentation of information • 4 navigation keys, 2 context-sensitive keys • Adjustable RUN/STOP function 	DIAG	EZAEBK1001

4.4

X400 diagnosis terminal

Mode		Features	Slot	Product key
X400 diagnosis terminal		<ul style="list-style-type: none"> • X400 keypad in a robust housing • Also suitable for installation in the control cabinet door • incl. 2.5 m cable • IP20 enclosure, IP65 for control cabinet installation on front face 	DIAG	EZAEBK2001

Servo Drives 9400 HighLine

Accessories



Shield connection kits for motor cable

The motor cable shielding can be connected to the shield plates of the installation backplanes or axis modules. To simplify the wiring, additional shield supports can be fitted to the shield plates. The shield support can easily be attached to a fixture on the shield plate and the connection cable just has to be passed through. For larger axis modules the shield support is part of the shield plate.

Mode	Features	Product key
Wire clamp	<ul style="list-style-type: none">Cable diameter: 4...15 mmPackaging unit: 10 items	EZAMBHXM006/M
	<ul style="list-style-type: none">Cable diameter: 10...20 mmPackaging unit: 10 items	EZAMBHXM003/M
	<ul style="list-style-type: none">Cable diameter: 15...28 mmPackaging unit: 10 items	EZAMBHXM004/M

Other accessories

Lenze offers a number of other automation components for the Servo Drives 9400. They do not form part of this product catalogue, but can be found in the Controller-based Automation and PC-based Automation catalogues. More specifically, this relates to the following components:

- Controllers
- Industrial PCs
- Remote maintenance components
- IO systems
- Human Machine Interfaces
- System bus adapters

Servo Drives 9400 HighLine

Accessories



4.4

Servo Drives 9400 HighLine

Accessories



Servo Drives 9400 HighLine

Accessories



Inverters

Inverter Drives 8400 TopLine

0.25 to 45 kW



Inverter Drives 8400 TopLine

Contents



General information		Product key	4.5 - 4
		Equipment	4.5 - 5
		List of abbreviations	4.5 - 6
		Inverter Drives 8400	4.5 - 8
		Functions and features	4.5 - 9
		Operating modes	4.5 - 10
Technical data		Standards and operating conditions	4.5 - 13
		Rated data 230 V	4.5 - 14
		Rated data 400 V	4.5 - 20
		"Cold plate" design	4.5 - 32
		Push-through technique design	4.5 - 34
Interfaces		Mains connection	4.5 - 36
		Motor connection	4.5 - 38
		Connection diagrams	4.5 - 40
		Control connections	4.5 - 42
		Memory module	4.5 - 44
		Safety system (STO)	4.5 - 44
		EtherCAT® communication module	4.5 - 46
		EtherNet/IP communication module	4.5 - 48
		POWERLINK communication module	4.5 - 50
		PROFIBUS communication module	4.5 - 52
		PROFINET communication module	4.5 - 54
Accessories		Brake resistors	4.5 - 56
Mains chokes		Operation at rated power	4.5 - 58
		Operation with increased power output	4.5 - 59
Interference suppression		Available RFI and mains filters	4.5 - 60
		Operation at rated power	4.5 - 61
		Operation with increased power output	4.5 - 63
Sinusoidal filters		Operation at rated power	4.5 - 66
		Operation with increased power output	4.5 - 67
Regenerative power supply modules		Rated data for power supply modules	4.5 - 68
		Rated data for regenerative power supply modules	4.5 - 70
		Control connections	4.5 - 72
		Brake resistors of the regenerative power supply modules	4.5 - 73
		Interference suppression of the regenerative power supply modules	4.5 - 74
		DC input module	4.5 - 76
		DC-bus connection	4.5 - 77
		24 V power supply unit	4.5 - 79
		Brake switch	4.5 - 79
		USB diagnostic adapter	4.5 - 80
		X400 keypad	4.5 - 81
		X400 diagnosis terminal	4.5 - 81
		PC system bus adapter	4.5 - 82
		Shield mounting	4.5 - 82
		Terminal strips	4.5 - 83
		Setpoint potentiometer	4.5 - 84

Inverter Drives 8400 TopLine

General information



Product key

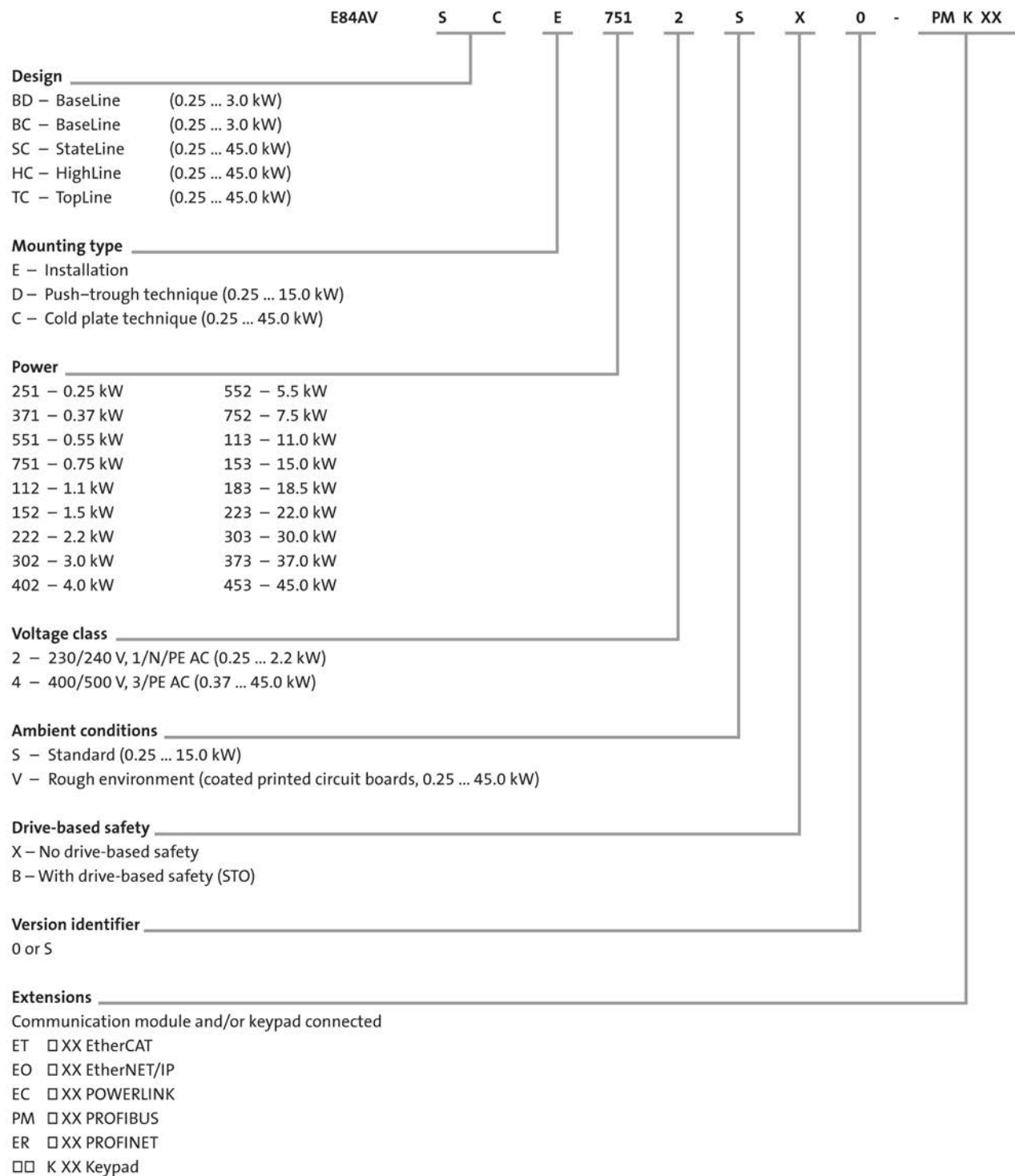

4.5

Inverter Drives 8400 TopLine

General information



Equipment

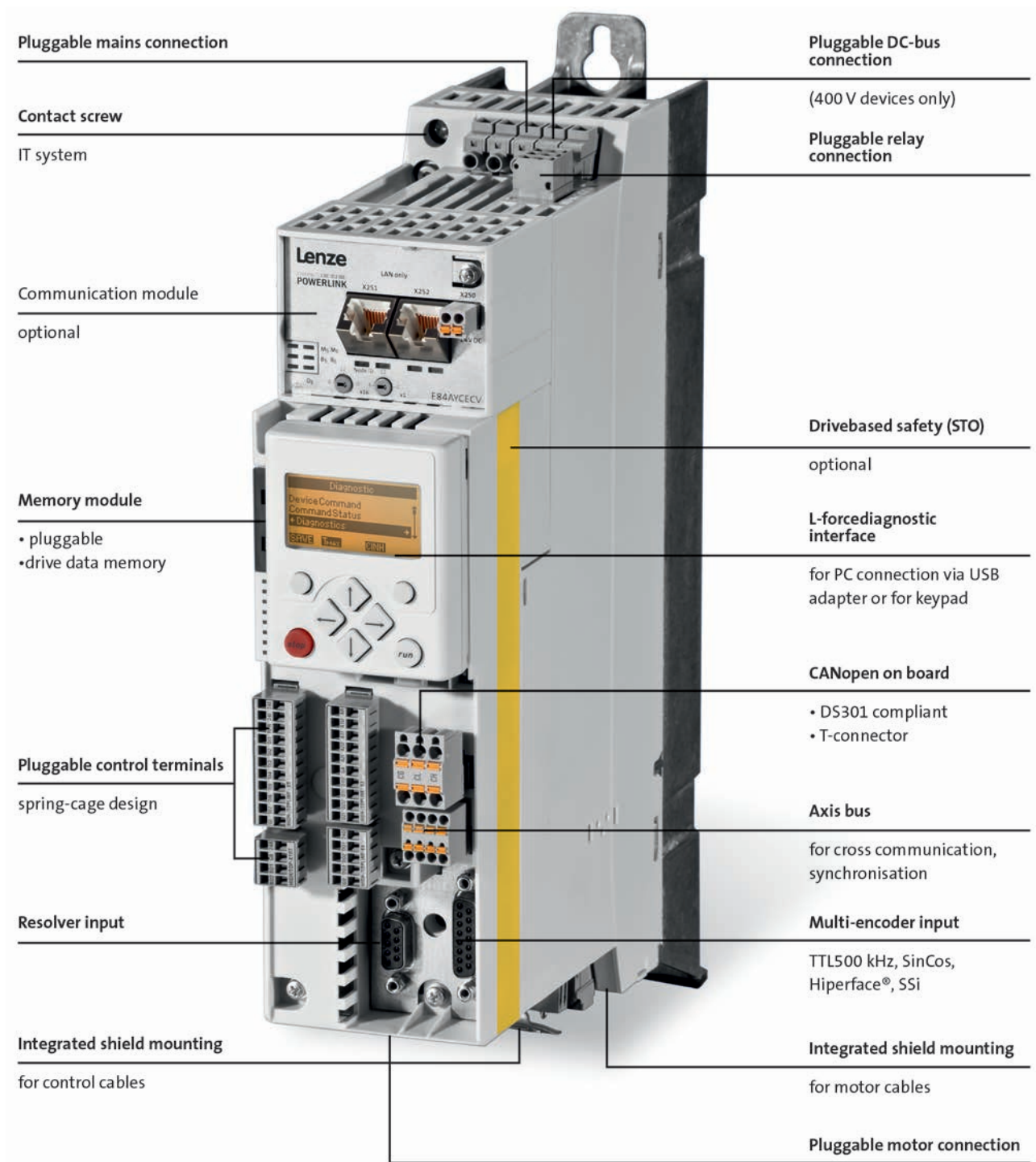

Inverter Drives 8400 TopLine

General information



List of abbreviations

b	[mm]	Dimensions
C _{th}	[kW _s]	Thermal capacity
f _{ch}	[kHz]	Rated switching frequency
h	[mm]	Dimensions
I _{N, out}	[A]	Rated output current
I _{N, AC}	[A]	Rated mains current
m	[kg]	Mass
n _{max}	[r/min]	Max. speed
P	[kW]	Typical motor power
P _V	[kW]	Power loss
P _N	[kW]	Rated power
R _N	[Ω]	Rated resistance
t	[mm]	Dimensions
U _{AC}	[V]	Mains voltage
U _{DC}	[V]	DC supply
U _{N, AC}	[V]	Rated voltage
U _{out}	[V]	Max. output voltage

ASM	Asynchronous motor
DIAG	Slot for diagnostic adapter
DIN	Deutsches Institut für Normung e.V.
EN	European standard
EN 60529	Degrees of protection provided by enclosures (IP code)
EN 60721-3	Classification of environmental conditions; Part 3: Classes of environmental parameters and their limit values
EN 61800-3	Electrical variable speed drives Part 3: EMC requirements including special test methods
IEC	International Electrotechnical Commission
IEC 61508	Functional safety of electrical/electronic/programmable electronic safety-related systems
IM	International Mounting Code
IP	International Protection Code
MCI	Slot for communication module (module communication interface)
NEMA	National Electrical Manufacturers Association
UL	Underwriters Laboratory Listed Product
UR	Underwriters Laboratory Recognized Product
VDE	Verband deutscher Elektrotechniker (Association of German Electrical Engineers)

Inverter Drives 8400 TopLine

General information



Inverter Drives 8400 TopLine

General information



Inverter Drives 8400

Cost-efficiency, time savings and quality enhancement are the challenges of the future. Lenze is facing these challenges with its L-force product portfolio – the holistic solution portfolio with precisely matched interfaces and components. For faster configuration and commissioning, better performance and more flexibility in production.

As such, the four versions of Inverter Drives 8400 - BaseLine, StateLine, HighLine and TopLine - have been designed for consistent process optimisation – throughout your entire value-added chain. They reduce your costs, from component selection, through project planning, manufacturing and commissioning, all the way up to servicing. We call this "rightsizing".

Rightsized for versatile applications

Are you looking to control a three-phase AC motor or perform positioning with or without feedback? Then select exactly the inverter you need from the scaled solution space of the Inverter Drives 8400 with units in the power range from 0.25 kW to 45 kW. You are sure to find exactly what you are looking for here, as the modular 8400 range of inverters offers the right solution for a broad spectrum of applications.

While the BaseLine is excellent for basic applications, the TopLine offers servo qualities and thereby fulfils with the strict requirements in terms of dynamics and accuracy.

8400 TopLine - for servo applications

8400 TopLine – the inverter with servo qualities within the 8400 range. Equipped with everything needed for high dynamic performance and accuracy in complex applications. Alongside a resolver input, a multiple encoder input (which can be used at the same time) is also provided which optimally supplements the range of feedback systems that can be used. Cross communication between multiple TopLine units requires minimum wiring (3-core), as it runs via the separate axis bus. Alongside asynchronous motors, TopLine also supports dynamic synchronous motors via feedback.

Benefit from precisely tailored, cost-optimised Lenze drive units, consisting of prepared system cables, motors and gearboxes, feedback, brakes, fans and of course the 8400 TopLine.

The 8400 TopLine is, for example, recommended for storage and retrieval units, synchronised line drives and pick-and-place applications.

Inverter Drives 8400 TopLine

General information



Functions and features

Mode	8400 TopLine
Control types, motor control	
Field-oriented servo control (SC)	For synchronous servo motors, asynchronous servo motors and three-phase asynchronous motors
Sensorless control (SLPSM)	For synchronous servo motors
Sensorless vector control (SLVC)	For three-phase asynchronous motors
V/f control (VFCplus)	For three-phase AC motors and asynchronous servo motor (linear or square-law)
Energy saving function (VFC eco)	For three-phase asynchronous motors
Basic functions	<ul style="list-style-type: none"> Freely assignable user menu Free function block interconnection with extensive function library Parameter change-over DC brake function Braking operation without brake resistor Brake management for brake control with low rate of wear Flying restart circuit S-shaped ramps for smooth acceleration PID controller 15 fixed frequencies Masking frequencies Inversion of motor phase sequence
Technology applications	<ul style="list-style-type: none"> Speed actuating drive Switch-off positioning without feedback Table positioning without feedback (with sequential positioning)
Advanced functions	<ul style="list-style-type: none"> Function blocks for positioning sequence control Function blocks for electrical shaft (speed and angular synchronism) Function blocks for dancer control Function blocks for mains failure control
Monitoring and protective measures	<ul style="list-style-type: none"> Short circuit Earth fault Overvoltage Motor phase failure Overcurrent I² x t-Motor monitoring Motor overtemperature Mains phase failure Protection for cyclical mains switching Motor stalling
Diagnostics	Data logger, logbook, oscilloscope functions
Status display	6 LEDs
Diagnostic interface	<ul style="list-style-type: none"> Integrated For USB diagnostic adapter or keypad (diagnosis terminal)
Braking operation	
Brake chopper	Integrated
Brake resistor	External

Inverter Drives 8400 TopLine

General information



Operating modes

An inverter enables energy-efficient operation of a system in virtually all application cases. The various operating modes, which can be created by making just a few simple settings, facilitate this. The following characteristics and corresponding specifications listed on the following pages can be used to calculate the optimum operating mode during the project planning phase.

Standard setting

In its initial state when delivered, the inverter is set up for basic operation with a three-phase AC motor with V/f control. When operated in this mode, the rated torque of the motor is available in a setting range up to 50 Hz.

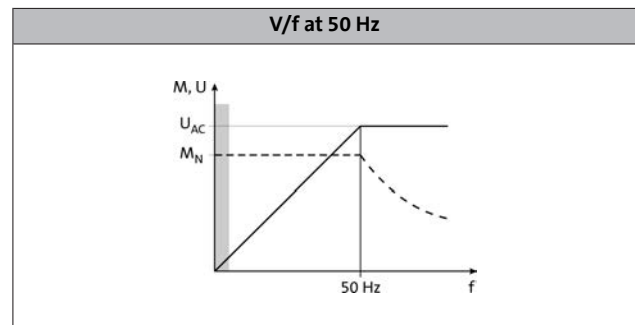

4.5

Extended setting range up to 87 Hz

If the V/f switchover point on the inverter is set to 87 Hz, the rated torque can be used across an extended setting range. Here, a 230/400V motor is for example used and operated in a delta layout with a 400V inverter. The setting range is then increased by 40 %. The inverter must be dimensioned for a rated motor current of 230 V.

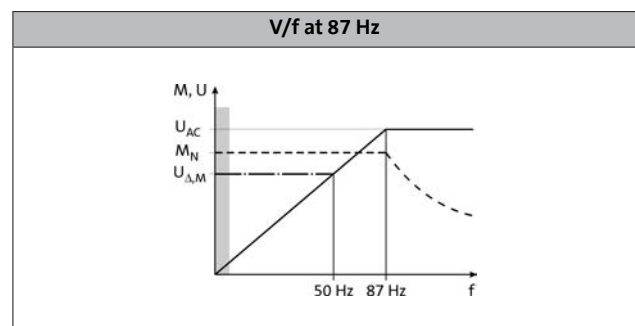

Operation with inverter-optimised MF motors

Large setting ranges and optimum operation at the rated torque: these are the strengths of the MF motor when used in combination with an inverter. The motors are optimised for a setting range up to 120 Hz. Compared to conventional 50Hz operation, the setting range increases by 250 %. It is quite simply not possible for a drive to be operated any more efficiently in a machine.

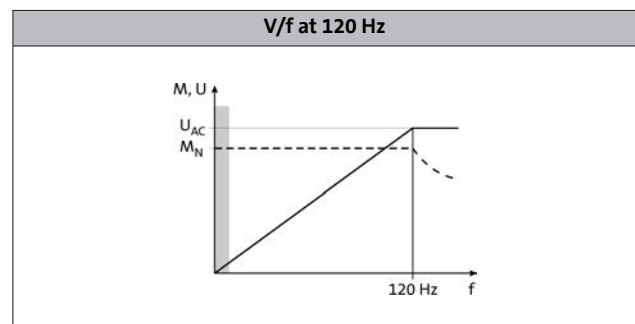

Operation with low loads

This operating mode can be used for various applications, e.g. for fans and pumps:

In fan and pump applications, the load behaviour follows a square-law characteristic depending on the speed. Often, an overload capacity of 120% is sufficient. This serves to operate the inverter during operation with increased power, i.e. the inverter can be dimensioned one power size smaller. The square-law characteristic which corresponds to the load behaviour can be set in the inverter.

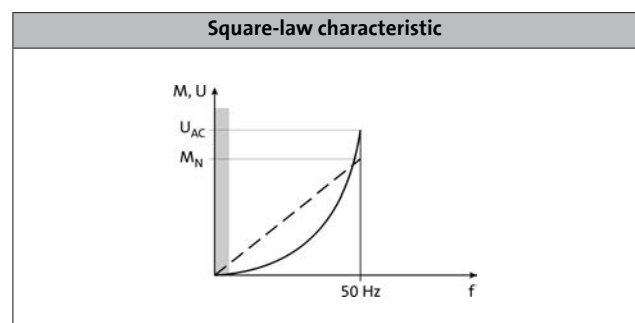

Inverter Drives 8400 TopLine



General information

Operating modes

VFC-eco energy saving mode

The Inverter Drives 8400 make energy saving especially easy with the "VFC eco" function. Particularly in the partial load operational range, this function significantly reduces energy requirements. Combined with the new L-force MF three-phase AC motors, this drive solution impresses with the maximum energy efficiency of a Lenze BlueGreen solution.

The "VFC eco" mode adjusts the magnetising current of a motor intelligently to actual requirements. This is particularly useful in partial load operational range, as this is precisely where three-phase AC motors need to be supplied with a greater magnetising current than the operating conditions actually require. The "VFC eco" mode allows losses to be reduced so much that savings of up to 30% can be achieved.

Energy efficiency can then be increased even further with the MF three-phase AC motors. These motors have been specifically designed for operation with frequency inverters. They operate at 120 Hz instead of 50 Hz, as 4-pole three-phase AC motors are at their most efficient at this frequency.

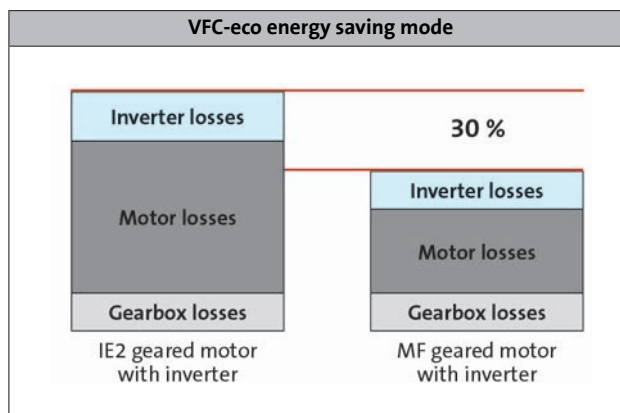

Overcurrent operation

The inverters can be driven at higher amperages beyond the rated current if the duration of this overcurrent operation is time limited. Two utilisation cycles with a duration of 15 s and 180 s are defined. Within these utilisation cycles, an overcurrent is possible for a certain time if afterwards an accordingly long recovery phase takes place. For both utilisation cycles, a moving average is determined separately. The adjacent diagram shows both cycles: 15 s in red and 180 s in blue. The overload times t_{o1} are 3 s (T_1) and 60 s (T_3) respectively, the corresponding recovery times t_{re} are 12 s (T_2) and 120 s (T_4) respectively. The following tables show the resulting maximum output currents. Monitoring of the device utilisation ($I \times t$) activates the set error response (trip or warning if one of the two utilisation values exceeds the limit of 100 %).

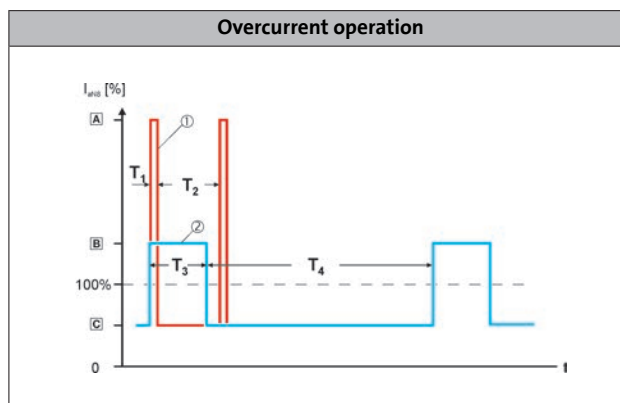

Switching frequencies

On an inverter, the term "switching frequency" is understood to mean the frequency with which the input and outputs of the output module (inverter) are switched. On an inverter, the switching frequency can generally be set to values between 2 and 16 kHz, whereby the selection is based on the respective power output.

Since losses (in the form of heat) can be generated when switching the modules, the inverter can provide a higher output current at a switching frequency of 2 kHz. In addition to this, it is also important to differentiate between operation at a fixed switching frequency and a variable switching frequency, whereby the switching frequency is automatically reduced based on the output current here.

The data for operation at increased output is permitted for operation at a switching frequency of 2 or 4 kHz and in an ambient temperature of max. 40 °C.

Inverter Drives 8400 TopLine

General information



4.5

Inverter Drives 8400 TopLine

Technical data



Standards and operating conditions

Mode			8400 TopLine
Product			8400 TopLine
Conformity			
CE			Low-Voltage Directive 2006/95/EC
EAC			TP TC 004/2011 (TR C) TP TC 020/2011 (TR C)
Approval			
UL 508C			Power Conversion Equipment (file no. E132659)
CSA ²⁾			CSA 22.2 No. 14
Enclosure			
EN 60529 ³⁾			IP20
NEMA 250			Type 1
Climatic conditions			
Storage (EN 60721-3-1)			1K3 (temperature: -25 °C ... +60 °C)
Transport (EN 60721-3-2)			2K3 (temperature: -25 °C ... +70 °C)
Operation (EN 60721-3-3)			3K3 (temperature: -10°C ... +55°C)
Current derating at over 45°C			2.5% / K
Site altitude			
Amsl	H _{max}	[m]	4000
Current derating at over 1000 m		[%/1000 m]	5
Vibration resistance			
Transport (EN 60721-3-2)			2M2
Operation (EN 61800-5-1)			10 Hz ≤ f ≤ 57 Hz: ±0.075 mm amplitude, 57 Hz ≤ f ≤ 150 Hz: 1.0 g
Operation (Germanischer Lloyd)			5 Hz ≤ f ≤ 13.2 Hz: ± 1 mm amplitude 13.2 Hz ≤ f ≤ 100 Hz: 0.7 g

4.5

Mode			8400 TopLine
Product			8400 TopLine
Supply form			
			Systems with earthed star point (TN and TT systems) Systems with high-resistance or isolated star point (IT systems)
Noise emission			
EN 61800-3			Integrated RFI suppression: category C2 up to 25 m shielded motor cable ¹⁾
Insulation resistance			
EN 61800-5-1			Overvoltage category III Above 2000 m amsl overvoltage category II
Degree of pollution			
EN 61800-5-1			2
Protective insulation of control circuits			
EN 61800-5-1			Safe mains isolation: double/reinforced insulation

¹⁾  38 - Please also refer to the Motor connection section

²⁾ When using an external mains choke or mains filter

³⁾ Mounted and ready-to-use

Inverter Drives 8400 TopLine

Technical data



Rated data 230 V

► Unless otherwise specified, the data refers to the default setting.

Data in left column per device

Operation with rated data: rated output current $I_{N,out}$ at mains voltage 230 V, switching frequency 8 kHz variable and max. ambient temperature 45 °C (default setting).
Output currents I_{out} apply to:
Ambient temperature 45 °C operating with constant switching frequency 2 kHz or 4 kHz.
Ambient temperature 40 °C operating with constant switching frequency 8 kHz or 16 kHz.

Data in right column per device

Operation with increased power: rated output current $I_{N,out}$ at mains voltage 230 V, switching frequency 4 kHz and max. ambient temperature 40 °C.
Output currents apply to:
Ambient temperature 40 °C operating with switching frequency 2 kHz or 4 kHz.

Typical motor power						
4-pole asynchronous motor	P	[kW]	0.25	0.37	0.37	0.55
Product key			E84AV□□□2512□□0		E84AV□□□3712□□0	
Mains voltage range			1/N/PE AC 180 V-0 % ... 264 V+0 %, 45 Hz-0 % ... 65 Hz+0 %			
	U_{AC}	[V]				
Rated mains current						
With mains choke	$I_{N,AC}$	[A]	3.0	3.6	4.2	5.0
Without mains choke	$I_{N,AC}$	[A]	3.4	4.1	5.0	
Rated output current						
	$I_{N,out}$	[A]	1.7	2.1	2.4	2.9
Output current						
2 kHz	I_{out}	[A]	1.7	2.1	2.4	2.9
4 kHz	I_{out}	[A]	1.7	2.1	2.4	2.9
8 kHz	I_{out}	[A]	1.7		2.4	
16 kHz	I_{out}	[A]	1.1		1.6	

Data for 60 s overload

Max. output current				
	$I_{max,out}$	[A]	2.6	3.6
Overload time			60.0	
	t_{ol}	[s]		
Recovery time			120.0	
	t_{re}	[s]		

Data for 3 s overload

Max. short-time output current				
	$I_{max,out}$	[A]	3.4	4.8
Overload time			3.0	
	t_{ol}	[s]		
Recovery time			12.0	
	t_{re}	[s]		

Inverter Drives 8400 TopLine

Technical data



Rated data 230 V

► Unless otherwise specified, the data refers to the default setting.

						
Typical motor power						
4-pole asynchronous motor	P	[kW]	0.25	0.37	0.37	0.55
Product key						
Inverter			E84AV□□□2512□□0		E84AV□□□3712□□0	
Power loss						
	P _V	[W]	45.0		50.0	
Max. cable length¹⁾						
Shielded motor cable	I _{max}	[m]	50			

Brake chopper rated data

4.5

Rated power, Brake chopper				
	P _N	[kW]	0.6	0.6
Max. output power, Brake chopper				
	P _{max, 1}	[kW]	0.8	0.8
Min. brake resistance				
	R _{min}	[Ω]	180.0	180.0

Dimensions and weights

Standard installation design

Dimensions				
Height	h	[mm]	215	215
Width	b	[mm]	70	70
Depth ²⁾	t	[mm]	214	214
Mass				
	m	[kg]	2.0	2.0

¹⁾ Technically possible cable lengths, irrespective of EMC requirements

²⁾ With safety engineering plus 20 mm

Inverter Drives 8400 TopLine

Technical data



Rated data 230 V

► Unless otherwise specified, the data refers to the default setting.

Data in left column per device

Operation with rated data: rated output current $I_{N,out}$ at mains voltage 230 V, switching frequency 8 kHz variable and max. ambient temperature 45 °C (default setting).
Output currents I_{out} apply to:
Ambient temperature 45 °C operating with constant switching frequency 2 kHz or 4 kHz.
Ambient temperature 40 °C operating with constant switching frequency 8 kHz or 16 kHz.

Data in right column per device

Operation with increased power: rated output current $I_{N,out}$ at mains voltage 230 V, switching frequency 4 kHz and max. ambient temperature 40 °C.
Output currents apply to:
Ambient temperature 40 °C operating with switching frequency 2 kHz or 4 kHz.

Typical motor power						
4-pole asynchronous motor	P	[kW]	0.55	0.75	0.75	1.10 ¹⁾
Product key						
Inverter			E84AV□□□5512□□0 E84AV□□□5512□□S		E84AV□□□7512□□0 E84AV□□□7512□□S	
Mains voltage range						
	U_{AC}	[V]	1/N/PE AC 180 V-0 % ... 264 V+0 %, 45 Hz-0 % ... 65 Hz+0 %			
Rated mains current						
With mains choke	$I_{N, AC}$	[A]	5.0	6.0	7.0	8.4
Without mains choke	$I_{N, AC}$	[A]	5.3	6.4	8.0	
Rated output current						
	$I_{N, out}$	[A]	3.0	3.6	4.0	4.8
Output current						
2 kHz	I_{out}	[A]	3.0	3.6	4.0	4.8
4 kHz	I_{out}	[A]	3.0	3.6	4.0	4.8
8 kHz	I_{out}	[A]	3.0		4.0	
16 kHz	I_{out}	[A]	2.0		2.7	

Data for 60 s overload

Max. output current						
	$I_{max, out}$	[A]	4.5		6.0	
Overload time						
	t_{ol}	[s]	60.0			
Recovery time						
	t_{re}	[s]	120.0			

Data for 3 s overload

Max. short-time output current						
	$I_{max, out}$	[A]	6.0		8.0	
Overload time						
	t_{ol}	[s]	3.0			
Recovery time						
	t_{re}	[s]	12.0			

¹⁾ Operation only permitted with mains choke

Inverter Drives 8400 TopLine

Technical data



Rated data 230 V

► Unless otherwise specified, the data refers to the default setting.

						
Typical motor power						
4-pole asynchronous motor	P	[kW]	0.55	0.75	0.75	1.10
Product key						
Inverter			E84AV□□□5512□□0 E84AV□□□5512□□S		E84AV□□□7512□□0 E84AV□□□7512□□S	
Power loss						
	P _V	[W]	60.0		75.0	
Max. cable length ¹⁾						
Shielded motor cable	I _{max}	[m]	50			

4.5

Brake chopper rated data

Rated power, Brake chopper				
	P _N	[kW]	1.1	1.1
Max. output power, Brake chopper				
	P _{max, 1}	[kW]	1.4	1.4
Min. brake resistance				
	R _{min}	[Ω]	100.0	100.0

Dimensions and weights

Standard installation design

Dimensions				
Height	h	[mm]	215	215
Width	b	[mm]	70	70
Depth ²⁾	t	[mm]	214	214
Mass				
	m	[kg]	2.0	2.0

¹⁾ Technically possible cable lengths, irrespective of EMC requirements

²⁾ With safety engineering plus 20 mm

Inverter Drives 8400 TopLine

Technical data



Rated data 230 V

► Unless otherwise specified, the data refers to the default setting.

Data in left column per device

Operation with rated data: rated output current $I_{N,out}$ at mains voltage 230 V, switching frequency 8 kHz variable and max. ambient temperature 45 °C (default setting).
Output currents I_{out} apply to:
Ambient temperature 45 °C operating with constant switching frequency 2 kHz or 4 kHz.
Ambient temperature 40 °C operating with constant switching frequency 8 kHz or 16 kHz.

Data in right column per device

Operation with increased power: rated output current $I_{N,out}$ at mains voltage 230 V, switching frequency 4 kHz and max. ambient temperature 40 °C.
Output currents apply to:
Ambient temperature 40 °C operating with switching frequency 2 kHz or 4 kHz.

Typical motor power							
4-pole asynchronous motor	P	[kW]	1.10	1.50	1.50	2.20 ¹⁾	2.20
Product key							
Inverter			E84AV□□□1122□□0 E84AV□□□1122□□S		E84AV□□□1522□□0 E84AV□□□1522□□S		E84AV□□□2222□□0 E84AV□□□2222□□S
Mains voltage range							
	U_{AC}	[V]	1/N/PE AC 180 V-0 % ... 264 V+0 %, 45 Hz-0 % ... 65 Hz+0 %				
Rated mains current							
With mains choke	$I_{N, AC}$	[A]	9.9	11.9	11.4	13.7	16.4
Without mains choke	$I_{N, AC}$	[A]	12.0	14.4	13.7		21.8
Rated output current							
	$I_{N, out}$	[A]	5.5	6.8	7.0	8.4	9.5
Output current							
2 kHz	I_{out}	[A]	5.5	6.8	7.0	8.4	9.5
4 kHz	I_{out}	[A]	5.5	6.8	7.0	8.4	9.5
8 kHz	I_{out}	[A]	5.5		7.0		9.5
16 kHz	I_{out}	[A]	3.7		4.7		6.3

Data for 60 s overload

Max. output current							
	$I_{max, out}$	[A]	8.3		10.5		14.3
Overload time							
	t_{ol}	[s]	60.0				
Recovery time							
	t_{re}	[s]	120.0				

Data for 3 s overload

Max. short-time output current							
	$I_{max, out}$	[A]	11.0		14.0		19.0
Overload time							
	t_{ol}	[s]	3.0				
Recovery time							
	t_{re}	[s]	12.0				

¹⁾ Operation only permitted with mains choke

Inverter Drives 8400 TopLine

Technical data



Rated data 230 V

► Unless otherwise specified, the data refers to the default setting.

									
Typical motor power									
4-pole asynchronous motor	P	[kW]	1.10	1.50	1.50	2.20	2.20	2.20	
Product key									
Inverter			E84AV□□□1122□□0 E84AV□□□1122□□S		E84AV□□□1522□□0 E84AV□□□1522□□S		E84AV□□□2222□□0 E84AV□□□2222□□S		
Power loss									
	P _V	[W]	95.0			110		140	
Max. cable length ¹⁾									
Shielded motor cable	I _{max}	[m]	50						

4.5

Brake chopper rated data

Rated power, Brake chopper								
	P _N	[kW]	3.3			3.3		3.3
Max. output power, Brake chopper								
	P _{max, 1}	[kW]	4.4			4.4		4.4
Min. brake resistance								
	R _{min}	[Ω]	33.0			33.0		33.0

Dimensions and weights

Standard installation design

Dimensions								
Height	h	[mm]	270			270		270
Width	b	[mm]	70			70		70
Depth ²⁾	t	[mm]	214			214		214
Mass								
	m	[kg]	2.3			2.3		2.3

¹⁾ Technically possible cable lengths, irrespective of EMC requirements

²⁾ With safety engineering plus 20 mm

Inverter Drives 8400 TopLine

Technical data



Rated data 400 V

► Unless otherwise specified, the data refers to the default setting.

Data in left column per device

Operation with rated data: rated output current $I_{N,out}$ at mains voltage 400 V, switching frequency 8 kHz variable and max. ambient temperature 45 °C (default setting).
Output currents I_{out} apply to:
Ambient temperature 45 °C operating with constant switching frequency 2 kHz or 4 kHz.
Ambient temperature 40 °C operating with constant switching frequency 8 kHz or 16 kHz.

Data in right column per device

Operation with increased power: rated output current $I_{N,out}$ at mains voltage 400 V, switching frequency 4 kHz constant and max. ambient temperature 40 °C.
Output currents apply to:
Ambient temperature 40 °C operating with constant switching frequency 2 kHz or 4 kHz.

Typical motor power								
4-pole asynchronous motor	P	[kW]	0.37	0.55	0.55	0.75	0.75	1.10 ¹⁾
Product key								
Inverter			E84AV□□□3714□□0 E84AV□□□3714□□S		E84AV□□□5514□□0 E84AV□□□5514□□S		E84AV□□□7514□□0 E84AV□□□7514□□S	
Mains voltage range								
	U_{AC}	[V]	3/PE AC 320 V-0 % ... 550 V+0 %, 45 Hz-0 % ... 65 Hz+0 %					
Rated mains current								
With mains choke	$I_{N, AC}$	[A]	1.4	1.7	2.0	2.6		3.0
Without mains choke	$I_{N, AC}$	[A]	1.8	2.2	2.5	3.2	3.6	
Rated output current								
	$I_{N, out}$	[A]	1.3	1.6	1.8	2.2	2.4	2.9
Output current								
2 kHz	I_{out}	[A]	1.3	1.6	1.8	2.2	2.4	2.9
4 kHz	I_{out}	[A]	1.3	1.6	1.8	2.2	2.4	2.9
8 kHz	I_{out}	[A]	1.3		1.8		2.4	
16 kHz	I_{out}	[A]	0.9		1.2		1.6	

Data for 60 s overload

Max. output current								
	$I_{max, out}$	[A]	2.0		2.7		3.6	
Overload time								
	t_{ol}	[s]	60.0					
Recovery time								
	t_{re}	[s]	120.0					

Data for 3 s overload

Max. short-time output current								
	$I_{max, out}$	[A]	2.6		3.6		4.8	
Overload time								
	t_{ol}	[s]	3.0					
Recovery time								
	t_{re}	[s]	12.0					

¹⁾ Operation only permitted with mains choke

Inverter Drives 8400 TopLine

Technical data



Rated data 400 V

► Unless otherwise specified, the data refers to the default setting.

Typical motor power								
4-pole asynchronous motor	P	[kW]	0.37	0.55	0.55	0.75	0.75	1.10
Product key								
Inverter			E84AV□□□3714□□0 E84AV□□□3714□□S	E84AV□□□5514□□0 E84AV□□□5514□□S	E84AV□□□7514□□0 E84AV□□□7514□□S			
DC supply								
	U_{DC}	[V]	DC 455 V -0 % ... 775 V +0 %					
Rated DC-bus current								
	$I_{N, DC}$	[A]	2.2		3.3		4.4	
Power loss								
	P_V	[W]	50.0		65.0		80.0	
Max. cable length¹⁾								
Shielded motor cable	l_{max}	[m]	50					

4.5

Brake chopper rated data

Rated power, Brake chopper					
	P_N	[kW]	1.3	1.3	1.3
Max. output power, Brake chopper					
	$P_{max, 1}$	[kW]	1.3	1.3	1.3
Min. brake resistance					
	R_{min}	[Ω]	390.0	390.0	390.0

Dimensions and weights

Standard installation design

Dimensions					
Height	h	[mm]	215	215	215
Width	b	[mm]	70	70	70
Depth ²⁾	t	[mm]	214	214	214
Mass					
	m	[kg]	2.0	2.0	2.0

¹⁾ Technically possible cable lengths, irrespective of EMC requirements

²⁾ With safety engineering plus 20 mm

Inverter Drives 8400 TopLine

Technical data



Rated data 400 V

► Unless otherwise specified, the data refers to the default setting.

Data in left column per device

Operation with rated data: rated output current $I_{N,out}$ at mains voltage 400 V, switching frequency 8 kHz variable and max. ambient temperature 45 °C (default setting).
Output currents I_{out} apply to:
Ambient temperature 45 °C operating with constant switching frequency 2 kHz or 4 kHz.
Ambient temperature 40 °C operating with constant switching frequency 8 kHz or 16 kHz.

Data in right column per device

Operation with increased power: rated output current $I_{N,out}$ at mains voltage 400 V, switching frequency 4 kHz constant and max. ambient temperature 40 °C.
Output currents apply to:
Ambient temperature 40 °C operating with constant switching frequency 2 kHz or 4 kHz.

										
Typical motor power										
4-pole asynchronous motor	P	[kW]	1.10	1.50	1.50	2.20	2.20	3.00 ¹⁾	3.00	4.00 ¹⁾
Product key										
Inverter			E84AV□□□1124□□0 E84AV□□□1124□□S	E84AV□□□1524□□0 E84AV□□□1524□□S	E84AV□□□2224□□0 E84AV□□□2224□□S	E84AV□□□3024□□S				
Mains voltage range			3/PE AC 320 V-0 % ... 550 V+0 %, 45 Hz-0 % ... 65 Hz+0 %							
	U_{AC}	[V]								
Rated mains current										
With mains choke	$I_{N, AC}$	[A]	3.2	3.8	3.9	4.7	5.1	6.1	7.0	8.4
Without mains choke	$I_{N, AC}$	[A]	4.4	5.3	5.5	6.6	7.3		9.8	
Rated output current										
	$I_{N, out}$	[A]	3.2	3.8	3.9	4.8	5.6	6.7	7.3	8.8
Output current										
2 kHz	I_{out}	[A]	3.2	3.8	3.9	4.8	5.6	6.7	7.3	8.8
4 kHz	I_{out}	[A]	3.2	3.8	3.9	4.8	5.6	6.7	7.3	8.8
8 kHz	I_{out}	[A]	3.2		3.9		5.6		7.3	
16 kHz	I_{out}	[A]	2.1		2.6		3.7		4.9	

Data for 60 s overload

Max. output current										
	$I_{max, out}$	[A]	4.8		5.9		8.4		11.0	
Overload time			60.0							
	t_{ol}	[s]								
Recovery time			120.0							
	t_{re}	[s]								

Data for 3 s overload

Max. short-time output current										
	$I_{max, out}$	[A]	6.4		7.8		11.2		14.6	
Overload time			3.0							
	t_{ol}	[s]								
Recovery time			12.0							
	t_{re}	[s]								

¹⁾ Operation only permitted with mains choke

Inverter Drives 8400 TopLine

Technical data



Rated data 400 V

► Unless otherwise specified, the data refers to the default setting.

Typical motor power										
4-pole asynchronous motor	P	[kW]	1.10	1.50	1.50	2.20	2.20	3.00	3.00	4.00
Product key										
Inverter			E84AV□□□1124□□□ E84AV□□□1124□□S	E84AV□□□1524□□□ E84AV□□□1524□□S	E84AV□□□2224□□□ E84AV□□□2224□□S	E84AV□□□3024□□□ E84AV□□□3024□□S				
DC supply										
	U_{DC}	[V]	DC 455 V -0 % ... 775 V +0 %							
Rated DC-bus current										
	$I_{N, DC}$	[A]	5.4	6.7	8.9	12.0				
Power loss										
	P_V	[W]	90.0	105	135	165				
Max. cable length¹⁾										
Shielded motor cable	l_{max}	[m]	50							

4.5

Brake chopper rated data

Rated power, Brake chopper										
	P_N	[kW]	2.9	2.9	3.5	6.4				
Max. output power, Brake chopper										
	$P_{max, 1}$	[kW]	2.9	2.9	3.5	6.4				
Min. brake resistance										
	R_{min}	[Ω]	180.0	180.0	150.0	82.0				

Dimensions and weights

Standard installation design

Dimensions										
Height	h	[mm]	270	270	270	270				
Width	b	[mm]	70	70	70	70				
Depth ²⁾	t	[mm]	214	214	214	214				
Mass										
	m	[kg]	2.3	2.3	2.3	2.3				

¹⁾ Technically possible cable lengths, irrespective of EMC requirements

²⁾ With safety engineering plus 20 mm

Inverter Drives 8400 TopLine

Technical data



Rated data 400 V

► Unless otherwise specified, the data refers to the default setting.

Data in left column per device

Operation with rated data: rated output current $I_{N,out}$ at mains voltage 400 V, switching frequency 8 kHz variable and max. ambient temperature 45 °C (default setting).
Output currents I_{out} apply to:
Ambient temperature 45 °C operating with constant switching frequency 2 kHz or 4 kHz.
Ambient temperature 40 °C operating with constant switching frequency 8 kHz or 16 kHz.

Data in right column per device

Operation with increased power: rated output current $I_{N,out}$ at mains voltage 400 V, switching frequency 4 kHz constant and max. ambient temperature 40 °C.
Output currents apply to:
Ambient temperature 40 °C operating with constant switching frequency 2 kHz or 4 kHz.

								
Typical motor power								
4-pole asynchronous motor	P	[kW]	3.00	4.00 ¹⁾	4.00	5.50	5.50	7.50 ¹⁾
Product key			E84AV□□□3024□□0		E84AV□□□4024□□0		E84AV□□□5524□□0	
Mains voltage range			3/PE AC 320 V-0 % ... 550 V+0 %, 45 Hz-0 % ... 65 Hz+0 %					
	U_{AC}	[V]						
Rated mains current								
With mains choke	$I_{N,AC}$	[A]	7.0	8.4	8.8	10.6	12.0	18.0
Without mains choke	$I_{N,AC}$	[A]	9.8		13.1	15.7	18.0	
Rated output current								
	$I_{N,out}$	[A]	7.3	8.8	9.5	11.5	13.0	15.6
Output current								
2 kHz	I_{out}	[A]	7.3	8.8	9.5	11.5	13.0	15.6
4 kHz	I_{out}	[A]	7.3	8.8	9.5	11.5	13.0	15.6
8 kHz	I_{out}	[A]	7.3		9.5		13.0	
16 kHz	I_{out}	[A]	4.9		6.3		8.7	

Data for 60 s overload

Max. output current							
	$I_{max,out}$	[A]	11.0		14.3		19.5
Overload time							
	t_{ol}	[s]			60.0		
Recovery time							
	t_{re}	[s]			120.0		

Data for 3 s overload

Max. short-time output current							
	$I_{max,out}$	[A]	14.6		19.0		26.0
Overload time							
	t_{ol}	[s]			3.0		
Recovery time							
	t_{re}	[s]			12.0		

¹⁾ Operation only permitted with mains choke

Inverter Drives 8400 TopLine

Technical data



Rated data 400 V

► Unless otherwise specified, the data refers to the default setting.

								
Typical motor power								
4-pole asynchronous motor	P	[kW]	3.00	4.00	4.00	5.50	5.50	7.50
Product key								
Inverter			E84AV□□□3024□□0		E84AV□□□4024□□0		E84AV□□□5524□□0	
DC supply								
	U_{DC}	[V]	DC 455 V -0 % ... 775 V +0 %					
Rated DC-bus current								
	$I_{N, DC}$	[A]	12.0		16.0		22.0	
Power loss								
	P_V	[W]	165		205		275	
Max. cable length¹⁾								
Shielded motor cable	I_{max}	[m]	50					

4.5

Brake chopper rated data

Rated power, Brake chopper					
	P_N	[kW]	6.4	9.4	9.4
Max. output power, Brake chopper					
	$P_{max, 1}$	[kW]	6.4	11.2	11.2
Min. brake resistance					
	R_{min}	[Ω]	82.0	47.0	47.0

Dimensions and weights

Standard installation design

Dimensions					
Height	h	[mm]	270	270	270
Width	b	[mm]	140	140	140
Depth ²⁾	t	[mm]	214	214	214
Mass					
	m	[kg]	4.6	4.6	4.6

¹⁾ Technically possible cable lengths, irrespective of EMC requirements

²⁾ With safety engineering plus 20 mm

Inverter Drives 8400 TopLine

Technical data



Rated data 400 V

► Unless otherwise specified, the data refers to the default setting.

Data in left column per device

Operation with rated data: rated output current $I_{N,out}$ at mains voltage 400 V, switching frequency 8 kHz variable and max. ambient temperature 45 °C (default setting).
Output currents I_{out} apply to:
Ambient temperature 45 °C operating with constant switching frequency 2 kHz or 4 kHz.
Ambient temperature 40 °C operating with constant switching frequency 8 kHz or 16 kHz.

Data in right column per device

Operation with increased power: rated output current $I_{N,out}$ at mains voltage 400 V, switching frequency 4 kHz constant and max. ambient temperature 40 °C.
Output currents apply to:
Ambient temperature 40 °C operating with constant switching frequency 2 kHz or 4 kHz.

							
Typical motor power							
4-pole asynchronous motor	P	[kW]	7.50	11.0	11.0	15.0 ¹⁾	15.0 ¹⁾
Product key			E84AV□□□7524□□0		E84AV□□□1134□□0		E84AV□□□1534□□0
Mains voltage range			3/PE AC 320 V-0 % ... 550 V+0 %, 45 Hz-0 % ... 65 Hz+0 %				
	U_{AC}	[V]					
Rated mains current							
With mains choke	$I_{N,AC}$	[A]	15.0	21.0	29.0		
Without mains choke	$I_{N,AC}$	[A]	20.0	28.0	29.0		
Rated output current							
	$I_{N,out}$	[A]	16.5	21.0	23.5	28.2	32.0
Output current							
2 kHz	I_{out}	[A]	16.5	21.0	23.5	28.2	32.0
4 kHz	I_{out}	[A]	16.5	21.0	23.5	28.2	32.0
8 kHz	I_{out}	[A]	16.5	23.5		32.0	
16 kHz	I_{out}	[A]	11.0	15.7		21.3	

Data for 60 s overload

Max. output current							
	$I_{max,out}$	[A]	26.4	35.3		48.0	
Overload time							
	t_{ol}	[s]	60.0				
Recovery time							
	t_{re}	[s]	120.0				

Data for 3 s overload

Max. short-time output current							
	$I_{max,out}$	[A]	33.0	47.0		64.0	
Overload time							
	t_{ol}	[s]	3.0				
Recovery time							
	t_{re}	[s]	12.0				

¹⁾ Operation only permitted with mains choke

Inverter Drives 8400 TopLine

Technical data



Rated data 400 V

► Unless otherwise specified, the data refers to the default setting.

							
Typical motor power							
4-pole asynchronous motor	P	[kW]	7.50	11.0	11.0	15.0	15.0
Product key							
Inverter			E84AV□□□7524□□0		E84AV□□□1134□□0		E84AV□□□1534□□0
DC supply							
	U_{DC}	[V]	DC 455 V -0 % ... 775 V +0 %				
Rated DC-bus current							
	$I_{N, DC}$	[A]	24.5		35.5		
Power loss							
	P_V	[W]	320		435		470
Max. cable length ¹⁾							
Shielded motor cable	I_{max}	[m]	50				

4.5

Brake chopper rated data

Rated power, Brake chopper					
	P_N	[kW]	19.5	19.5	29.2
Max. output power, Brake chopper					
	$P_{max, 1}$	[kW]	19.5	19.5	29.2
Min. brake resistance					
	R_{min}	[Ω]	27.0	27.0	18.0

Dimensions and weights

Standard installation design

Dimensions					
Height	h	[mm]	325	325	325
Width	b	[mm]	140	140	140
Depth ²⁾	t	[mm]	214	214	214
Mass					
	m	[kg]	6.0	6.0	6.0

¹⁾ Technically possible cable lengths, irrespective of EMC requirements

²⁾ With safety engineering plus 20 mm

Inverter Drives 8400 TopLine

Technical data



Rated data 400 V

► Unless otherwise specified, the data refers to the default setting.

Data in left column per device

Operation with rated data: rated output current $I_{N,out}$ at mains voltage 400 V, switching frequency 8 kHz variable and max. ambient temperature 45 °C (default setting).
Output currents I_{out} apply to:
Ambient temperature 45 °C operating with constant switching frequency 2 kHz or 4 kHz.
Ambient temperature 40 °C operating with constant switching frequency 8 kHz or 16 kHz.

Data in right column per device

Operation with increased power: rated output current $I_{N,out}$ at mains voltage 400 V, switching frequency 4 kHz constant and max. ambient temperature 40 °C.
Output currents apply to:
Ambient temperature 40 °C operating with constant switching frequency 2 kHz or 4 kHz.

						
Typical motor power						
4-pole asynchronous motor	P	[kW]	18.5	22.0 ¹⁾	22.0 ¹⁾	30.0 ¹⁾
Product key			E84AV□□□1834□□0		E84AV□□□2234□□0	
Mains voltage range			3/PE AC 320 V-0 % ... 550 V+0 %, 45 Hz-0 % ... 65 Hz+0 %			
	U_{AC}	[V]				
Rated mains current						
With mains choke	$I_{N,AC}$	[A]	36.0	42.2	42.0	50.8
Without mains choke	$I_{N,AC}$	[A]	50.4			
Rated output current						
	$I_{N,out}$	[A]	40.0	46.8	47.0	56.4
Output current						
2 kHz	I_{out}	[A]	40.0	46.8	47.0	56.4
4 kHz	I_{out}	[A]	40.0	46.8	47.0	56.4
8 kHz	I_{out}	[A]	40.0		47.0	
16 kHz	I_{out}	[A]	27.0		31.3	

Data for 60 s overload

Max. output current						
	$I_{max,out}$	[A]	60.0		70.5	
Overload time						
	t_{ol}	[s]	60.0			
Recovery time						
	t_{re}	[s]	120.0			

Data for 3 s overload

Max. short-time output current						
	$I_{max,out}$	[A]	78.0		89.3	
Overload time						
	t_{ol}	[s]	3.0			
Recovery time						
	t_{re}	[s]	12.0			

¹⁾ Operation only permitted with mains choke or mains filter

Inverter Drives 8400 TopLine

Technical data



Rated data 400 V

► Unless otherwise specified, the data refers to the default setting.

						
Typical motor power						
4-pole asynchronous motor	P	[kW]	18.5	22.0	22.0	30.0
Product key			E84AV□□□1834□□0		E84AV□□□2234□□0	
DC supply			DC 455 V -0 % ... 775 V +0 %			
	U_{DC}	[V]				
Rated DC-bus current			44.1		51.4	
	$I_{N, DC}$	[A]				
Power loss			540		640	
	P_V	[W]				
Max. cable length¹⁾			100			
Shielded motor cable	I_{max}	[m]				

4.5

Brake chopper rated data

Rated power, Brake chopper			35.0		35.0	
	P_N	[kW]				
Max. output power, Brake chopper			35.0		35.0	
	$P_{max, 1}$	[kW]				
Min. brake resistance			15.0		15.0	
	R_{min}	[Ω]				

Dimensions and weights

Standard installation design

Dimensions						
Height	h	[mm]	350		350	
Width	b	[mm]	205		205	
Depth ²⁾	t	[mm]	265		265	
Mass						
	m	[kg]	12.2		12.2	

¹⁾ Technically possible cable lengths, irrespective of EMC requirements

²⁾ With safety engineering plus 20 mm

Inverter Drives 8400 TopLine

Technical data



Rated data 400 V

► Unless otherwise specified, the data refers to the default setting.

Data in left column per device

Operation with rated data: rated output current $I_{N,out}$ at mains voltage 400 V, switching frequency 8 kHz variable and max. ambient temperature 45 °C (default setting).
Output currents I_{out} apply to:
Ambient temperature 45 °C operating with constant switching frequency 2 kHz or 4 kHz.
Ambient temperature 40 °C operating with constant switching frequency 8 kHz or 16 kHz.

Data in right column per device

Operation with increased power: rated output current $I_{N,out}$ at mains voltage 400 V, switching frequency 4 kHz constant and max. ambient temperature 40 °C.
Output currents apply to:
Ambient temperature 40 °C operating with constant switching frequency 2 kHz or 4 kHz.

								
Typical motor power								
4-pole asynchronous motor	P	[kW]	30.0 ¹⁾	37.0 ¹⁾	37.0 ¹⁾	45.0 ¹⁾	45.0 ¹⁾	55.0 ¹⁾
Product key			E84AV□□□3034□□0		E84AV□□□3734□□0		E84AV□□□4534□□0	
Mains voltage range			3/PE AC 320 V-0 % ... 550 V+0 %, 45 Hz-0 % ... 65 Hz+0 %					
Rated mains current								
With mains choke	$I_{N,AC}$	[A]	55.0	66.0	68.0	81.6	80.0	96.0
Without mains choke	$I_{N,AC}$	[A]						
Rated output current								
	$I_{N,out}$	[A]	61.0	73.2	76.0	91.2	89.0	106.8
Output current								
2 kHz	I_{out}	[A]	61.0	73.2	76.0	91.2	89.0	106.8
4 kHz	I_{out}	[A]	61.0	73.2	76.0	91.2	89.0	106.8
8 kHz	I_{out}	[A]	61.0		76.0		89.0	
16 kHz	I_{out}	[A]	41.0		51.0		60.0	

Data for 60 s overload

Max. output current								
	$I_{max,out}$	[A]	91.5		114.0		133.5	
Overload time								
	t_{ol}	[s]	60.0					
Recovery time								
	t_{re}	[s]	120.0					

Data for 3 s overload

Max. short-time output current								
	$I_{max,out}$	[A]	112.1		136.8		169.1	
Overload time								
	t_{ol}	[s]	3.0					
Recovery time								
	t_{re}	[s]	12.0					

¹⁾ Operation only permitted with mains choke or mains filter

Inverter Drives 8400 TopLine

Technical data



Rated data 400 V

► Unless otherwise specified, the data refers to the default setting.

							
Typical motor power							
4-pole asynchronous motor	P	[kW]	30.0	37.0	37.0	45.0	45.0
Product key							
Inverter			E84AV□□□3034□□0		E84AV□□□3734□□0		E84AV□□□4534□□0
DC supply							
	U_{DC}	[V]	DC 455 V -0 % ... 775 V +0 %				
Rated DC-bus current							
	$I_{N, DC}$	[A]	67.4		83.3		98.0
Power loss							
	P_V	[W]	840		980		1300
Max. cable length¹⁾							
Shielded motor cable	I_{max}	[m]	100				

4.5

Brake chopper rated data

Rated power, Brake chopper					
	P_N	[kW]	70.1	70.1	70.1
Max. output power, Brake chopper					
	$P_{max, 1}$	[kW]	70.1	70.1	70.1
Min. brake resistance					
	R_{min}	[Ω]	7.5	7.5	7.5

Dimensions and weights

Standard installation design

Dimensions					
Height	h	[mm]	450	450	450
Width	b	[mm]	250	250	250
Depth ²⁾	t	[mm]	265	265	265
Mass					
	m	[kg]	17.4	17.4	17.4

¹⁾ Technically possible cable lengths, irrespective of EMC requirements

²⁾ With safety engineering plus 20 mm

Inverter Drives 8400 TopLine

Technical data



"Cold plate" design

Inverters in cold-plate design dissipate some of their waste heat (heat loss) via a cooler adapted to the application. For this purpose, the inverters are provided with a planed cooling plate which is connected to a separate cooler in a thermally conductive way. Using the cold plate technology, the main part of the heat energy can be transferred directly to the external cooling units.

The use of cold-plate technology is advantageous for the following application cases:

- Minimising the expense of cooling the control cabinet. Here, the main part of the power loss is directly transferred to a cooling unit outside of the control cabinet, e.g. convection cooler or water cooler.
- Heavily polluted ambient air or control cabinets with a high degree of protection which do not allow for a use of a forced air cooling of the control cabinets.
- Low mounting depth in the control cabinet.

Requirements for the cooler

When cold-plate technology is used, the following basic conditions must be considered:

- Good thermal connection to the external cooling unit, i.e. the implementation of the heat transfer resistance (R_{th}) according to the power loss.
- The contact surface must at least be as big as the cooling plate of the inverter.
- The planarity of the contact surface must not exceed 0.05 mm.
- The contact surface of the external coolers and cooling plate must be connected by means of the intended screwed connection.
- The maximum temperature of the cooling plate of the inverter ((75 °C) must not be exceeded.

Product key	Power to be dissipated	Thermal resistance
Inverter	P_V	R_{th}
	[W]	[K/W]
E84AV□□□2512□□□	15.0	≤ 1.5
E84AV□□□3712□□□	20.0	≤ 1.5
E84AV□□□5512□□S	30.0	≤ 1.0
E84AV□□□7512□□S	40.0	≤ 1.0
E84AV□□□1122□□S	60.0	≤ 0.6
E84AV□□□1522□□S	75.0	≤ 0.5
E84AV□□□2222□□S	100	≤ 0.4
E84AV□□□3714□□S	25.0	≤ 1.0
E84AV□□□5514□□S	35.0	≤ 1.0
E84AV□□□7514□□S	50.0	≤ 1.0
E84AV□□□1124□□S	60.0	≤ 0.6
E84AV□□□1524□□S	70.0	≤ 0.5
E84AV□□□2224□□S	100	≤ 0.4
E84AV□□□3024□□S	100	≤ 0.4
E84AV□□□4024□□□	155	≤ 0.25
E84AV□□□5524□□□	215	≤ 0.18
E84AV□□□7524□□□	250	≤ 0.15
E84AV□□□1134□□□	355	≤ 0.11
E84AV□□□1534□□□	390	≤ 0.10
E84AV□□□1834□□□	460	≤ 0.057
E84AV□□□2234□□□	540	≤ 0.057
E84AV□□□3034□□□	720	≤ 0.053
E84AV□□□3734□□□	810	≤ 0.047
E84AV□□□4534□□□	1080	≤ 0.035

Dimensions and weights

Product key			E84AV□□□2512□□□	E84AV□□□3712□□□	E84AV□□□5512□□S	E84AV□□□7512□□S
Inverter						
Dimensions						
Height, including fastening	h	[mm]	236			
Width, including fastening	b	[mm]	70			
Depth	t	[mm]	178			
Mass						
	m	[kg]	1.7			

Product key			E84AV□□□1122□□S	E84AV□□□1522□□S	E84AV□□□2222□□S
Inverter					
Dimensions					
Height, including fastening	h	[mm]	295		
Width, including fastening	b	[mm]	70		
Depth	t	[mm]	178		
Mass					
	m	[kg]	2.2		

Inverter Drives 8400 TopLine

Technical data



"Cold plate" design

Dimensions and weights

Product key			E84AV□□□3714□□S	E84AV□□□5514□□S	E84AV□□□7514□□S
Inverter					
Dimensions					
Height, including fastening	h	[mm]	236		
Width, including fastening	b	[mm]	70		
Depth ¹⁾	t	[mm]	178		
Mass					
	m	[kg]	1.7		

Product key			E84AV□□□1124□□S	E84AV□□□1524□□S	E84AV□□□2224□□S
Inverter					
Dimensions					
Height, including fastening	h	[mm]	295		
Width, including fastening	b	[mm]	70		
Depth ¹⁾	t	[mm]	178		
Mass					
	m	[kg]	2.2		

4.5

Product key			E84AV□□□3024□□S	E84AV□□□4024□□0	E84AV□□□5524□□0	E84AV□□□7524□□0
Inverter						
Dimensions						
Height, including fastening	h	[mm]	295	318		378
Width, including fastening	b	[mm]	70		174	
Depth ¹⁾	t	[mm]	178		156	
Mass						
	m	[kg]	2.2	2.9		3.8

Product key			E84AV□□□1134□□0	E84AV□□□1534□□0	E84AV□□□1834□□0	E84AV□□□2234□□0
Inverter						
Dimensions						
Height, including fastening	h	[mm]	378			407
Width, including fastening	b	[mm]	174			231
Depth ¹⁾	t	[mm]	156			179
Mass						
	m	[kg]	3.8			9.5

Product key			E84AV□□□3034□□0	E84AV□□□3734□□0	E84AV□□□4534□□0
Inverter					
Dimensions					
Height, including fastening	h	[mm]	520		
Width, including fastening	b	[mm]	250		
Depth ¹⁾	t	[mm]	199		
Mass					
	m	[kg]	16.9		

¹⁾ With safety engineering plus 20 mm

Inverter Drives 8400 TopLine

Technical data



Push-through technique design

The inverters in push-through design reduce the waste heat in the control cabinet.

The inverter is mounted in the control cabinet such that the heatsink of the inverter is outside the control cabinet. Thus, the entire waste heat can be dissipated outside the control cabinet via convection or forced air cooling for almost all device performances. For inverters with a power below 2.2 kW, restrictions may occur.

Using the push-through technology is advantageous in the following application cases:

- Minimising the expense for control cabinet cooling. For this purpose, the main part of the power loss is directly transferred to the ambience outside the control cabinet (e.g. convection cooling).
- In case of control cabinets with a high degree of protection > IP54 by using separate mounting and cooling areas.
- Low mounting depth in the control cabinet.

Inverter Drives 8400 TopLine

Technical data



Push-through technique design

Dimensions and weights

Product key				E84AV□□□2512□□0	E84AV□□□3712□□0	E84AV□□□5512□□0	E84AV□□□7512□□0
Inverter							
Dimensions							
Height, including fastening	h	[mm]					236
Width, including fastening	b	[mm]					102
Depth (in control cabinet) ¹⁾	t	[mm]					178
Mass							
	m	[kg]					2.1

Product key				E84AV□□□1122□□0	E84AV□□□1522□□0	E84AV□□□2222□□0	E84AV□□□3714□□0
Inverter							
Dimensions							
Height, including fastening	h	[mm]		295		236	
Width, including fastening	b	[mm]		137		102	
Depth (in control cabinet) ¹⁾	t	[mm]		178			
Mass							
	m	[kg]		3.7		2.1	

4.5

Product key				E84AV□□□5514□□0	E84AV□□□7514□□0	E84AV□□□1124□□0	E84AV□□□1524□□0
Inverter							
Dimensions							
Height, including fastening	h	[mm]		236		295	
Width, including fastening	b	[mm]		102		137	
Depth (in control cabinet) ¹⁾	t	[mm]		178			
Mass							
	m	[kg]		2.1		3.7	

Product key				E84AV□□□2224□□0	E84AV□□□3024□□0	E84AV□□□4024□□0	E84AV□□□5524□□0
Inverter							
Dimensions							
Height, including fastening	h	[mm]		295		318	
Width, including fastening	b	[mm]		137		174	
Depth (in control cabinet) ¹⁾	t	[mm]		178		156	
Mass							
	m	[kg]		3.7		5.1	

Product key				E84AV□□□7524□□0	E84AV□□□1134□□0	E84AV□□□1534□□0
Inverter						
Dimensions						
Height, including fastening	h	[mm]		378		
Width, including fastening	b	[mm]		174		
Depth (in control cabinet) ¹⁾	t	[mm]		156		
Mass						
	m	[kg]		6.4		

¹⁾ With safety engineering plus 20 mm

Inverter Drives 8400 TopLine

Interfaces



Mains connection

- ▶ The mains fuse and cable cross-section specifications are for a mains connection of 1 x 230V or 3 x 400V.
- ▶ Class gG/gI fuses or class gRL semiconductor fuses.
- ▶ The cable cross-sections apply to PVC-insulated copper cables.
- ▶ Use for installation with UL-approved cables, fuses and brackets.

Operation with mains choke

Typical motor power	Mains voltage	Product key	Circuit breaker	Fuse		Mains connection
				EN 60204-1	UL	
4-pole asynchronous motor		Inverter				Cross-section (with mains choke)
P	U _{AC}		I	I	I	q
[kW]	[V]		[A]	[A]	[A]	[mm ²]
0.25	1 AC 180 ... 264	E84AV□□□2512□□0	C6	6	6	1.0
0.37		E84AV□□□3712□□0			10	
0.55		E84AV□□□5512□□0	C10	10	15	1.5
0.75		E84AV□□□7512□□0			20	
1.10		E84AV□□□1122□□0	C16	16	25	2.5
1.50		E84AV□□□1522□□0			30	
2.20		E84AV□□□2222□□0	C20	20	30	4.0
0.37		3 AC 320 ... 550	E84AV□□□3714□□0	C6	6	6
0.55	E84AV□□□5514□□0					
0.75	E84AV□□□7514□□0					
1.10	E84AV□□□1124□□0		C10	10	10	1.5
1.50	E84AV□□□1524□□0					
2.20	E84AV□□□2224□□0		C16	16	15	2.5
3.00	E84AV□□□3024□□0					
4.00	E84AV□□□4024□□0		C20	20	20	4.0
5.50	E84AV□□□5524□□0					
7.50	E84AV□□□7524□□0		C32	32	30	10.0
11.0	E84AV□□□1134□□0					
15.0	E84AV□□□1534□□0		C50	50	40	16.0
18.5	E84AV□□□1834□□0					
22.0	E84AV□□□2234□□0		C63	63	50	25.0
30.0	E84AV□□□3034□□0		C80	80	70	
37.0	E84AV□□□3734□□0		C100	100	80	50.0
45.0	E84AV□□□4534□□0		C125	125	100	

- ▶ Data are valid also for inverters with type code E84AV□□□□□□□□□□S

4.5

Inverter Drives 8400 TopLine

Interfaces



Mains connection

Operation without mains choke

Typical motor power	Mains voltage	Product key	Circuit breaker	Fuse		Mains connection
				EN 60204-1	UL	
4-pole asynchronous motor		Inverter				Cross-section (without mains choke)
P	U _{AC}		I	I	I	q
[kW]	[V]		[A]	[A]	[A]	[mm ²]
0.25	1 AC 180... 264	E84AV□□□2512□□0	C6	6	6	1.0
0.37		E84AV□□□3712□□0			10	
0.55		E84AV□□□5512□□0	C10	10	15	1.5
0.75		E84AV□□□7512□□0				
1.10		E84AV□□□1122□□0	C16	16	20	2.5
1.50		E84AV□□□1522□□0	C20	20	25	4.0
2.20		E84AV□□□2222□□0	C25	25	30	
0.37		3 AC 320... 550	E84AV□□□3714□□0	C15	6	6
0.55	E84AV□□□5514□□0					
0.75	E84AV□□□7514□□0					
1.10	E84AV□□□1124□□0					
1.50	E84AV□□□1524□□0		C20	10	10	1.5
2.20	E84AV□□□2224□□0					
3.00	E84AV□□□3024□□0		C25	16	15	2.5
4.00	E84AV□□□4024□□0				20	
5.50	E84AV□□□5524□□0		C25	25	25	4.0
7.50	E84AV□□□7524□□0		C32	32	25	10.0
11.0	E84AV□□□1134□□0				40	
18.5	E84AV□□□1834□□0		C80	80	60	25.0

4.5

► Data are valid also for inverters with type code E84AV□□□□□□□□□□S

Inverter Drives 8400 TopLine

Interfaces



Motor connection

- ▶ Keep motor cables as short as possible, as this has a positive effect on the drive behaviour.
- ▶ With group drives (multiple motors on one inverter), the resulting cable length is the key factor. This can be calculated using the hardware manual.
- ▶ Electric strength of the motor cable: 1 kV as per VDE 250-1.
- ▶ Capacitance per unit length
 $\leq 1.5 \text{ mm}^2 / \text{AWG 16}: C_{\text{core-core}} / C_{\text{core-shield}} \leq 75 / \leq 150 \text{ pF/m}$
 $\geq 2.5 \text{ mm}^2 / \text{AWG 12}: C_{\text{core-core}} / C_{\text{core-shield}} \leq 100 / \leq 150 \text{ pF/m}$

Typical motor power	Mains voltage	Product key	Max. cable length (shielded)			Max. cable length shielded C2		
			4 kHz (without limit value)	8 kHz (without limit value)	16 kHz (without limit value)	Integrated filter	RFI filter SD	RFI filter LD
P	U _{AC}	Inverter	l	l	l	l	l	l
[kW]	[V]		[m]	[m]	[m]	[m]	[m]	[m]
0.25	1 AC 180 ... 264	E84AV□□□□2512□□0	50.0	50.0	50.0	25	50	100
0.37		E84AV□□□□3712□□0						
0.55		E84AV□□□□5512□□0						
0.75		E84AV□□□□7512□□0						
1.10		E84AV□□□□1122□□0						
1.50		E84AV□□□□1522□□0						
2.20		E84AV□□□□2222□□0						
0.37	3 AC 320 ... 550	E84AV□□□□3714□□0	50.0	25.0	15.0	25	50	100
0.55		E84AV□□□□5514□□0						
0.75		E84AV□□□□7514□□0						
1.10		E84AV□□□□1124□□0						
1.50		E84AV□□□□1524□□0						
2.20		E84AV□□□□2224□□0						
3.00		E84AV□□□□3024□□0						
4.00		E84AV□□□□4024□□0						
5.50		E84AV□□□□5524□□0						
7.50		E84AV□□□□7524□□0						
11.0	E84AV□□□□1134□□0							
15.0	E84AV□□□□1534□□0							
18.5	E84AV□□□□1834□□0							
22.0	E84AV□□□□2234□□0							
30.0	E84AV□□□□3034□□0							
37.0	E84AV□□□□3734□□0							
45.0	E84AV□□□□4534□□0							

- ▶ Data are valid also for inverters with type code E84AV□□□□□□□□□□S

4.5

Inverter Drives 8400 TopLine

Interfaces



Motor connection

Operation with earth-leakage circuit breaker

If the inverter is connected via an earth-leakage circuit breaker, the following cable lengths are permissible, although the table must also be taken into account:

Earth-leakage circuit breaker 30 mA:

- 0.25 to 2.2 kW (230 V, Category C1) up to 5 m shielded motor cable with RFI filter LL
- 0.25 to 2.2 kW up to 25 m shielded motor cable with integrated RFI measures
- 0.25 to 15 kW up to 25 m shielded motor cable with RFI filter SD.

Earth-leakage circuit breaker 300 mA:

- 3.0 to 45 kW up to 25 m shielded motor cable with integrated RFI measures
- 0.25 to 45 kW up to 50 m shielded motor cable with RFI filter LD.

- ▶ When using an earth-leakage circuit breaker and RFI filter, the cable lengths can also be used for Category C1, cable-guided.

Inverter Drives 8400 TopLine

Interfaces



Connection diagrams

Wiring example for connecting Inverter Drives 8400 TopLine to 1 x 230V

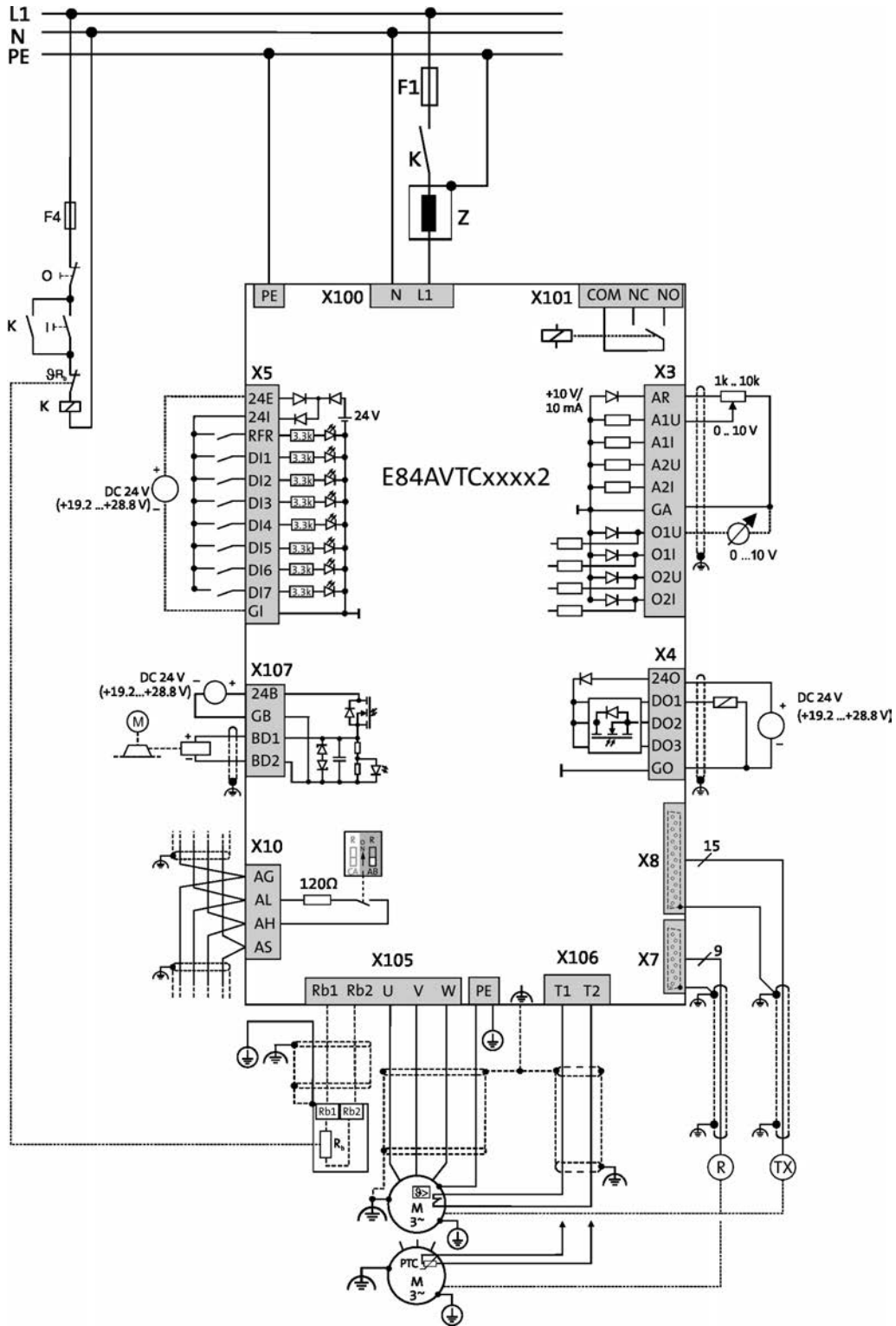

4.5

Inverter Drives 8400 TopLine

Interfaces



Connection diagrams

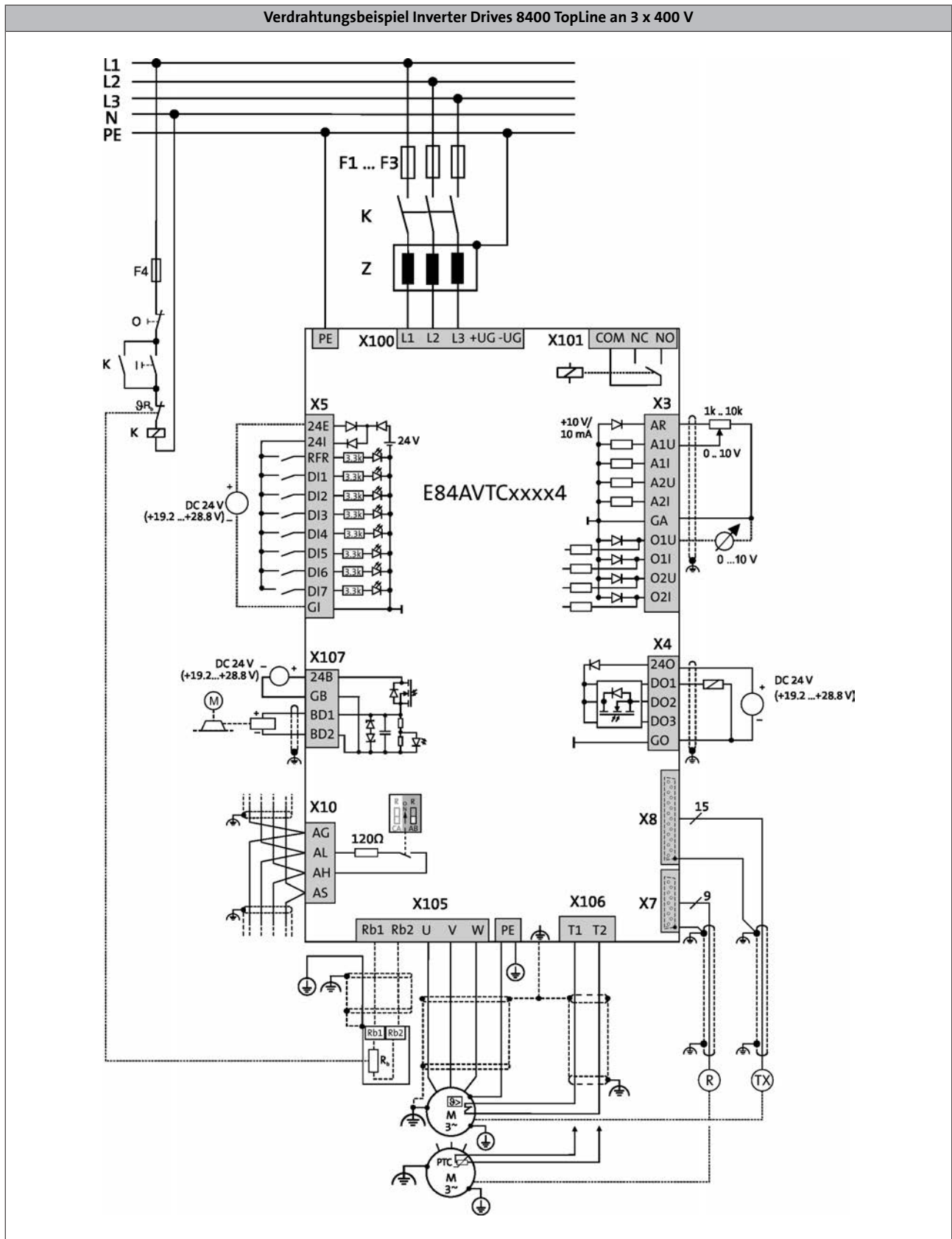

Inverter Drives 8400 TopLine

Interfaces



Control connections

Mode	8400 TopLine
Analog inputs	
Number	2 Optional: voltage or current input
Resolution	10 bits + sign
Value range	0 ... +/- 10V, 0/4 ... 20 mA
Analog outputs	
Number	2 Optional: voltage or current output
Resolution	10 bits
Value range	0 ... 10V, 0/4 ... 20mA
Digital inputs	
Number	8
Switching level	PLC (IEC 61131-2)
Max. input current	11 mA
Function	2 inputs, can optionally be used as a frequency input (10 kHz, 2-track)
Digital outputs	
Number	4
Switching level	PLC (IEC 61131-2)
Max. output current	1 x 2.5 A, (basic insulation, with spark suppressor, e.g. for 24 V service brake) 3 x 50 mA
Relay	
Number	1
Contact	Changeover contact
AC connection	250V, 3A
DC connection	24V, 2A ... 240V, 0.16A
External DC supply	
Rated voltage ¹⁾	24 V
Interfaces	
CANopen	Integrated functional insulated Max. baud rate 1.000 kbps DIP switch for address, baud rate, bus termination
Extensions	optional communication module
Safety engineering	Optional Safe torque off (STO)
Drive interface	
Axis bus	for cross communication and synchronisation of several 8400 TopLine devices
Encoder input	Sub-D, 15-pin Multiple encoder input for: TTL incremental encoder, SinCos incremental or absolute value encoder, SSI absolute value encoder KTY temperature sensor evaluation Via 2 digital inputs, HTL, 2-track, 200 kHz can also be used as a frequency input,
Resolver input	Sub-D, 9-pin

¹⁾ For mains-independent control electronics supply

Inverter Drives 8400 TopLine

Interfaces



Memory module

All drive settings for the 8400 are stored on the memory module, which is a pluggable memory chip. The memory module ensures that drives can be replaced quickly and without errors being made.

Mode	Features	Product key
Memory module	<ul style="list-style-type: none">• For 8400 StateLine, HighLine, Topline and protec• Packaging unit: 5 items	E84AYM10S/M

- Each inverter is equipped with a memory module in the factory

Safety system (STO)

The 8400 StateLine, HighLine and TopLine models are optionally available with "STO safe torque off" safety engineering. This helps reduce control system costs, save space in the control cabinet and keep wiring to a minimum. The safety engineering is certified to EN ISO 13849-1 (Cat. 4, PL e), EN 61508/EN 62061 (SIL 3).

The inverters can optionally be ordered with integrated safety engineering (STO). In this case, the product key of the inverter has a "B" as the 14th character.

By way of an example, a StateLine 230 V, 0.55 kW built-in unit with safety engineering would be: E84AVSCE5512SB0



8400 StateLine with safety engineering

Inverter Drives 8400 TopLine

Interfaces



Inverter Drives 8400 TopLine

Interfaces



EtherCAT® communication module

A communication module is used to connect the 8400 StateLine, HighLine or TopLine to a bus system.



EtherCAT® communication module

4.5

Mode		Features	Slot	Product key
Communication module				
EtherCAT		<ul style="list-style-type: none"> • Distributed clock • 5 LEDs for status display • 2 RJ45 connections with LEDs for link and activity • Connection option for separate 24 V supply 	MCI	E84AYCETV/S

- ▶ The Inverter Drives 8400 can be ordered with a plug-in EtherCAT® communication module already installed. If you would like to order the products in this complete form, please add the inverter product key as follows when placing your order: E84AV to X-ETXXX
- ▶ The product key with the supplement for the applied module is provided in our sales documents. This information is not part of the nameplate of the device.

Standards and operating conditions

Product key				E84AYCETV/S
Mode				EtherCAT
Enclosure				IP20
Climatic conditions				
Storage (EN 60721-3-1)				1K3 (temperature: -25 °C ... +60 °C)
Transport (EN 60721-3-2)				2K3 (temperature: -25 °C ... +70 °C)
Operation (EN 60721-3-3)				3K3 (temperature: -10°C ... +55°C)
Insulation voltage to reference earth/PE				
EN 61800-5-1	U_{AC}	[V]		50.0

Inverter Drives 8400 TopLine

Interfaces



EtherCAT® communication module

Rated data

Product key			E84AYCETV/S
Communication			
Medium			CAT5e S/FTP according to ISO/ICE11801 (2002)
Communication profile			CoE (CANopen over EtherCAT)
Baud rate			
	b	[MBit/s]	100
Node			
			Slave
Network topology			
			Line
Number of logical process data channels			
			1
Process data words (PZD)			
16 Bit			1 ... 16
Number of bus nodes			
			Max. 65535
Max. cable length			
between two nodes	l_{\max}	[m]	100

4.5

Inverter Drives 8400 TopLine

Interfaces



EtherNet/IP communication module

A communication module is used to connect the 8400 StateLine, HighLine or TopLine to a bus system.



EtherNet/IP communication module

4.5

Mode		Features	Slot	Product key
Communication module				
EtherNet/IP		<ul style="list-style-type: none"> • 5 LEDs for status display • 2 RJ45 connections with LEDs for link and activity • Address can be set via 2 rotary DIP switches • TCP/IP channel • ODVA certification (Open Device Vendor Association) • Supported assembly object instances as per ODVA: 20, 21, 22, 23 and 70, 71, 72, 73 • Manufacturer-specific supported assembly object instances (custom): 110 and 111 • Connection option for separate 24 V supply 	MCI	E84AYCEOV/S

- ▶ The Inverter Drives 8400 can be ordered with a plug-on PROFINET communication module already installed. If you would like to order the products in this complete form, please add the inverter product key as follows when placing your order: E84AV to X-EOXXX
- ▶ The product key with the supplement for the applied module is provided in our sales documents. This information is not part of the nameplate of the device.

Standards and operating conditions

Product key				E84AYCEOV/S
Mode				EtherNet/IP
Enclosure				IP20
EN 60529				
Climatic conditions				
Storage (EN 60721-3-1)				1K3 (temperature: -25 °C ... +60 °C)
Transport (EN 60721-3-2)				2K3 (temperature: -25 °C ... +70 °C)
Operation (EN 60721-3-3)				3K3 (temperature: -10°C ... +55°C)
Insulation voltage to reference earth/PE				
EN 61800-5-1	U _{AC}	[V]		50.0

Inverter Drives 8400 TopLine

Interfaces



EtherNet/IP communication module

Rated data

Product key			E84AYCEOV/S
Communication			
Medium			CAT5e S/FTP according to ISO/ICE11801 / EN50173
Communication profile			EtherNET/IP, AC Drive
Baud rate			
	b	[MBit/s]	10/100 (full duplex/half duplex)
Node			
			Slave (Adapter)
Network topology			
			Tree, star and line
Process data words (PZD)			
16 Bit			1 ... 16
Number of bus nodes			
			max. 254 im Subnetz
Max. cable length			
between two nodes	l_{\max}	[m]	100

4.5

Inverter Drives 8400 TopLine

Interfaces



POWERLINK communication module

A communication module is used to connect the 8400 StateLine, HighLine or TopLine to a bus system.



POWERLINK communication module

4.5

Mode		Features	Slot	Product key
Communication module				
POWERLINK CN		<ul style="list-style-type: none"> • Sync mode, Multiplex mode • 5 LEDs for status display • 2 x RJ45 connections with LEDs for link and collision • Connection option for separate 24 V supply 	MCI	E84AYCECV/S

- ▶ The Inverter Drives 8400 can be ordered with a plug-in POWERLINK communication module already installed. If you would like to order the products in this complete form, please add the inverter product key as follows when placing your order: E84AV to X-ECXXX
- ▶ The product key with the supplement for the applied module is provided in our sales documents. This information is not part of the nameplate of the device.

Standards and operating conditions

Product key				E84AYCECV/S
Mode				POWERLINK CN
Enclosure				IP20
Climatic conditions				
Storage (EN 60721-3-1)				1K3 (temperature: -25 °C ... +60 °C)
Transport (EN 60721-3-2)				2K3 (temperature: -25 °C ... +70 °C)
Operation (EN 60721-3-3)				3K3 (temperature: -10°C ... +55°C)
Insulation voltage to reference earth/PE				
EN 61800-5-1	U_{AC}	[V]		50.0

Inverter Drives 8400 TopLine

Interfaces



POWERLINK communication module

Rated data

Product key			E84AYCECV/S
Communication			
Medium			CAT5e S/FTP according to ISO/ICE11801 (2002)
Communication profile			EPL2.0
Baud rate			
	b	[MBit/s]	100
Node			
			Controlled node (CN)
Network topology			
			bei Verwendung von externen Hubs Line bei Verwendung der internen Hubs Tree
Number of logical process data channels			
			1
Process data words (PZD)			
16 Bit			1 ... 16
Number of bus nodes			
			max. 239
Max. cable length			
between two nodes	I_{max}	[m]	100
Rated voltage			
	$U_{N,DC}$	[V]	24.0

4.5

Ethernet POWERLINK Hub

Lenze offers an external 8-way hub, supplementing the 2-way hub integrated in the Ethernet POWERLINK interface connections. This infrastructure component corresponds to a class-II repeater as per IEEE802.3u. It automatically detects the network baud rate (10 or 100 Mbps). The hubs can be cascaded via a special uplink port.



Ethernet POWERLINK Hub

Mode		Features	Product key
Communication module			
POWERLINK hub		<ul style="list-style-type: none"> • DC 24 V • Automatic baud rate detection (10/100 Mbps) • 8-fold hub in industrial design • Cascadable 	E94AZCEH

Inverter Drives 8400 TopLine

Interfaces



PROFIBUS communication module

A communication module is used to connect the 8400 StateLine, HighLine or TopLine to a bus system.



PROFIBUS communication module

4.5

Mode		Features	Slot	Product key
Communication module				
PROFIBUS		<ul style="list-style-type: none"> • 5 LEDs for status display • Sub-D connection • Address can be set via DIP switch 	MCI	E84AYCPMV/S

- ▶ The Inverter Drives 8400 can be ordered with a plug-in PROFIBUS communication module already installed. If you would like to order the products in this complete form, please add the inverter product key as follows when placing your order: E84AV to X-PMXXX
- ▶ The product key with the supplement for the applied module is provided in our sales documents. This information is not part of the nameplate of the device.

Standards and operating conditions

Product key				E84AYCPMV/S
Mode				PROFIBUS
Enclosure				IP20
Climatic conditions				
Storage (EN 60721-3-1)				1K3 (temperature: -25 °C ... +60 °C)
Transport (EN 60721-3-2)				2K3 (temperature: -25 °C ... +70 °C)
Operation (EN 60721-3-3)				3K3 (temperature: -10°C ... +55°C)
Insulation voltage to reference earth/PE				
EN 61800-5-1	U_{AC}	[V]		50.0

Inverter Drives 8400 TopLine

Interfaces



PROFIBUS communication module

Rated data

Product key			E84AYCPMV/S
Communication			
Medium			RS 485
Communication profile			PROFIBUS-DP-V1 PROFIBUS-DP-V0
Device profile			PROFIDrive, version 3
Baud rate			
	b	[kBit/s]	9.6 ... 12 000 (automatic detection)
Node			
			Slave
Network topology			
			Line with repeater: Line or tree without repeater:
Process data words (PZD)			
16 Bit			1 ... 16
DP user data length			
			Optional parameter channel (4 words) + process data words
Number of bus nodes			
			31 slaves + 1 master per bus segment With repeaters: 125
Max. cable length			
per bus segment	l_{\max}	[m]	1200 (depending on the baud rate and the cable type used)

4.5

Inverter Drives 8400 TopLine

Interfaces



PROFINET communication module

A communication module is used to connect the 8400 StateLine, HighLine or TopLine to a bus system.



PROFINET communication module

4.5

Mode		Features	Slot	Product key
Communication module				
PROFINET		<ul style="list-style-type: none"> • 5 LEDs for status display • 2 RJ45 connections with LEDs for link and activity • TCP/IP channel • Connection option for separate 24 V supply 	MCI	E84AYCERV/S

- ▶ The Inverter Drives 8400 can be ordered with a plug-on PROFINET communication module already installed. If you would like to order the products in this complete form, please add the inverter product key as follows when placing your order: E84AV to X-ER-XXX
- ▶ The product key with the supplement for the applied module is provided in our sales documents. This information is not part of the nameplate of the device.

Standards and operating conditions

Product key				E84AYCERV/S
Mode				PROFINET
Enclosure				IP20
EN 60529				
Climatic conditions				
Storage (EN 60721-3-1)				1K3 (temperature: -25 °C ... +60 °C)
Transport (EN 60721-3-2)				2K3 (temperature: -25 °C ... +70 °C)
Operation (EN 60721-3-3)				3K3 (temperature: -10°C ... +55°C)
Insulation voltage to reference earth/PE				
EN 61800-5-1	U_{AC}	[V]		50.0

Inverter Drives 8400 TopLine

Interfaces



PROFINET communication module

Rated data

Product key			E84AYCERV/S
Communication			
Medium			CAT5e S/FTP according to ISO/ICE11801 (2002)
Communication profile			PROFINET RT Conf. Class B
Baud rate			
	b	[MBit/s]	100
Node			
			Slave (Device)
Network topology			
			Line
Number of logical process data channels			
			1
Process data words (PZD)			
16 Bit			1 ... 16
Max. cable length			
between two nodes	l_{\max}	[m]	100

4.5

Inverter Drives 8400 TopLine

Accessories



Brake resistors

An external brake resistor is required to brake high moments of inertia or in the event of prolonged operation in generator mode; this resistor converts braking energy into heat.

The brake resistors recommended in the table below have been dimensioned for approx. 1.5 times the regenerative power, with a cycle time of 15/135 s (brake/rest ratio). These brake resistors generally meet the usual requirements of standard applications.

The brake resistors are fitted with a thermostat (potential-free NC contact).



ERBM...(IP50) brake resistor

Typical motor power	Mains voltage	Product key		Rated resistance	Rated power	Thermal capacity	Dimensions	Mass
		Inverter	Brake resistor					
4-pole asynchronous motor								
P	U _{AC}			R _N	P _N	C _{th}	h x b x t	m
[kW]	[V]			[Ω]	[kW]	[KWs]	[mm]	[kg]
0.25	1 AC 180... 264	E84AV□□□□2512□□0	ERBM180R050W	180.0	50.0	7.50	175 x 20.6 x 40	0.3
0.37		E84AV□□□□3712□□0						
0.55		E84AV□□□□5512□□0	ERBM100R100W	100.0	100.0	15.0	240 x 80 x 95	0.5
0.75		E84AV□□□□7512□□0						
1.10		E84AV□□□□1122□□0	ERBP033R200W	33.0	200.0	30.0	240 x 41 x 122	1.0
1.50		E84AV□□□□1522□□0						
2.20		E84AV□□□□2222□□0	ERBP033R300W		300.0	45.0	320 x 41 x 122	1.4
0.37	3 AC 320... 550	E84AV□□□□3714□□0	ERBM390R100W	390.0	100.0	15.0	235 x 20.6 x 40	0.4
0.55		E84AV□□□□5514□□0						
0.75		E84AV□□□□7514□□0	ERBP180R200W	180.0	200.0	30.0	240 x 41 x 122	1.0
1.10		E84AV□□□□1124□□0						
1.50		E84AV□□□□1524□□0	ERBP180R300W		300.0	45.0	320 x 41 x 122	1.4
2.20		E84AV□□□□2224□□0						

► Data are valid also for inverters with type code E84AV□□□□□□□□□□S

▶ Data sheet on ERBM brake resistors
DS_ZB_ERBM_0001
Available for download at www.lenze.de/dsc

▶ Data sheet on ERBP brake resistors
DS_ZB_ERBP_0001
Available for download at www.lenze.de/dsc

▶ Data sheet on ERBP brake resistors
DS_ZB_ERBP_0001
Available for download at www.lenze.de/dsc

▶ Data sheet on ERBS brake resistors
DS_ZB_ERBS_0001
Available for download at www.lenze.com/dsc

Inverter Drives 8400 TopLine

Accessories



Brake resistors

For standard applications, we recommend the following combinations:

- E84AV□□□3024□□□ and ERBP180R300W
- E84AV□□□4024□□□ and ERBS047R400W
- E84AV□□□5524□□□ and ERBS047R800W
- E84AV□□□7524□□□ and ERBS027R01K2
- E84AV□□□1134□□□ and ERBS027R01K2
- E84AV□□□1534□□□ and ERBS018R01K4
- E84AV□□□1834□□□ and ERBS015R02K4
- E84AV□□□2234□□□ and ERBS015R02K4.



Other possible combinations:

ERBP...(IP21) and ERBS...(IP65) brake resistor

Typical motor power	Mains voltage	Product key		Rated resistance	Rated power	Thermal capacity	Dimensions	Mass
		Inverter	Brake resistor					
P	U _{AC}			R _N	P _N	C _{th}	h x b x t	m
[kW]	[V]			[Ω]	[kW]	[KWs]	[mm]	[kg]
3.00	3 AC 320... 550	E84AV□□□3024□□□	ERBP180R300W	180.0	300.0	45.0	320 x 41 x 122	1.4
			ERBP082R200W	82.0	200.0	30.0		1.0
			ERBS082R780W		780.0	117	666 x 124 x 122	4.0
4.00		E84AV□□□4024□□□	ERBP047R200W	47.0	200.0	30.0	320 x 41 x 122	1.0
			ERBS047R400W		400.0	60.0	400 x 110 x 105	2.3
			ERBS047R800W		800.0	120	710 x 110 x 105	3.9
5.50		E84AV□□□5524□□□	ERBP047R200W		200.0	30.0	320 x 41 x 122	1.0
			ERBS047R400W		400.0	60.0	400 x 110 x 105	2.3
			ERBS047R800W		800.0	120	710 x 110 x 105	3.9
7.50		E84AV□□□7524□□□	ERBP027R200W	27.0	200.0	30.0	320 x 41 x 122	1.0
			ERBS027R600W		600.0	90.0	550 x 110 x 105	3.1
			ERBS027R01K2		1200.0	180	1020 x 110 x 105	5.6
11.0	E84AV□□□1134□□□	ERBP027R200W	200.0		30.0	320 x 41 x 122	1.0	
		ERBS027R600W	600.0		90.0	550 x 110 x 105	3.1	
		ERBS027R01K2	1200.0		180	1020 x 110 x 105	5.6	
15.0	E84AV□□□1534□□□	ERBS018R800W	18.0	800.0	120	710 x 110 x 105	3.9	
		ERBS018R01K4		1400.0	210	1110 x 110 x 105	6.2	
		ERBS018R02K8		2800.0	420	1110 x 200 x 105	12.0	
18.5	E84AV□□□1834□□□	ERBS015R800W	15.0	800.0	120	710 x 110 x 105	3.9	
		ERBS015R01K2		1200.0	180	1020 x 110 x 105	5.6	
		ERBS015R02K4		2400.0	420	1020 x 200 x 105	10.0	
22.0	E84AV□□□2234□□□	ERBS015R800W		800.0	120	710 x 110 x 105	3.9	
		ERBS015R01K2		1200.0	180	1020 x 110 x 105	5.6	
		ERBS015R02K4		2400.0	420	1020 x 200 x 105	10.0	
30.0	E84AV□□□3034□□□	ERBG075D01K9	7.5	1900.0	285	486 x 236 x 302	9.5	
37.0	E84AV□□□3734□□□							
45.0	E84AV□□□4534□□□							

► Data are valid also for inverters with type code E84AV□□□□□□□□□□S

Inverter Drives 8400 TopLine

Accessories



Mains chokes

A mains choke is an inductive resistor which is connected in the mains cable of the power supply module. The use of a mains choke provides the following advantages:

- **Fewer effects on the mains:**
The wave form of the mains current is a close approximation to a sine wave.
- **Reduction in the effective mains current:**
Reduction of mains, cable and fuse loads

Mains chokes can be used without restrictions in conjunction with RFI filters and/or sinusoidal filters.



Mains choke

Please note:

: The use of a mains choke slightly reduces the mains voltage at the input of the inverter - the typical voltage drop across the mains choke at the rated values is around 5%.

Operation at rated power

Typical motor power	Mains voltage	Product key		Rated current	Dimensions	Mass
		Inverter	Mains choke			
4-pole asynchronous motor						
P	U_{AC}			I_N	h x b x t	m
[kW]	[V]			[A]	[mm]	[kg]
0.25	1 AC 180 ... 264	E84AV□□□2512□□□□	ELN1-0900H005	5.00	75 x 66 x 82	1.1
0.37		E84AV□□□3712□□□□				
0.55		E84AV□□□5512□□□□	ELN1-0500H009	9.00		
0.75		E84AV□□□7512□□□□				
1.10		E84AV□□□1122□□□□	ELN1-0250H018	18.0		
1.50		E84AV□□□1522□□□□				
2.20		E84AV□□□2222□□□□				
0.37	3 AC 320 ... 550	E84AV□□□3714□□□□	EZAELN3002B153	2.00	56 x 77 x 100	0.5
0.55		E84AV□□□5514□□□□	EZAELN3004B732	4.00	60 x 95 x 114	1.3
0.75		E84AV□□□7514□□□□				
1.10		E84AV□□□1124□□□□				
1.50		E84AV□□□1524□□□□	EZAELN3006B492	6.00	69 x 95 x 117	1.5
2.20		E84AV□□□2224□□□□				
3.00		E84AV□□□3024□□□□	EZAELN3008B372	8.00	85 x 120 x 137	1.9
4.00		E84AV□□□4024□□□□	EZAELN3010B292	10.0	85 x 120 x 134	2.0
5.50		E84AV□□□5524□□□□	EZAELN3016B182	16.0	95 x 120 x 134	2.7
7.50		E84AV□□□7524□□□□	EZAELN3020B152	20.0	95 x 155 x 162	3.8
11.0		E84AV□□□1134□□□□	EZAELN3025B122	25.0	110 x 155 x 167	5.8
15.0		E84AV□□□1534□□□ ¹⁾	EZAELN3035B841	35.0		6.0
18.5		E84AV□□□1834□□□□	EZAELN3045B651	45.0	112 x 185 x 196	8.3
22.0		E84AV□□□2234□□□ ¹⁾	EZAELN3050B591	50.0	112 x 185 x 208	8.4
30.0		E84AV□□□3034□□□ ¹⁾	EZAELN3063B471	63.0	122 x 185 x 207	9.7
37.0	E84AV□□□3734□□□ ¹⁾	EZAELN3080B371	80.0	125 x 210 x 239	12.5	
45.0	E84AV□□□4534□□□ ¹⁾	EZAELN3090B331	90.0	115 x 267 x 201	16.0	

¹⁾ Operation only permitted with mains choke

► Data are valid also for inverters with type code E84AV□□□□□□□□□□\$

► On some inverters, a mains filter (combination of RFI filter and mains choke) can be used in place of a mains choke. Information on this can be found in the "Interference suppression" section.

Inverter Drives 8400 TopLine

Accessories



Mains chokes

Operation with increased power output



Mains choke

Typical motor power	Mains voltage	Product key		Rated current	Dimensions	Mass
		Inverter	Mains choke			
4-pole asynchronous motor						
P	U_{AC}			I_N	h x b x t	m
[kW]	[V]			[A]	[mm]	[kg]
0.37	1 AC 180 ... 264	E84AV□□□2512□□□	ELN1-0900H005	5.00	75 x 66 x 82	1.1
0.55		E84AV□□□3712□□□				
0.75		E84AV□□□5512□□□	ELN1-0500H009	9.00		
1.10		E84AV□□□7512□□□ ¹⁾				
1.50		E84AV□□□1122□□□	ELN1-0250H018	18.0		
2.20		E84AV□□□1522□□□ ¹⁾				
0.55	3 AC 320 ... 550	E84AV□□□3714□□□	EZAELN3002B153	2.00	56 x 77 x 100	0.5
0.75		E84AV□□□5514□□□	EZAELN3004B732	4.00	60 x 95 x 114	1.3
1.10		E84AV□□□7514□□□ ¹⁾				
1.50		E84AV□□□1124□□□	EZAELN3006B492	6.00	69 x 95 x 117	1.5
2.20		E84AV□□□1524□□□				
3.00		E84AV□□□2224□□□ ¹⁾	EZAELN3008B372	8.00	85 x 120 x 137	1.9
4.00		E84AV□□□3024□□□	EZAELN3010B292	10.0	85 x 120 x 134	2.0
5.50		E84AV□□□4024□□□	EZAELN3016B182	16.0	95 x 120 x 134	2.7
7.50		E84AV□□□5524□□□ ¹⁾	EZAELN3020B152	20.0	95 x 155 x 162	3.8
11.0		E84AV□□□7524□□□	EZAELN3025B122	25.0	110 x 155 x 167	5.8
15.0		E84AV□□□1134□□□ ¹⁾	EZAELN3030B102	30.0		5.9
22.0		E84AV□□□1834□□□ ¹⁾	EZAELN3045B651	45.0	112 x 185 x 196	8.3
30.0		E84AV□□□2234□□□ ¹⁾	EZAELN3063B471	63.0	122 x 185 x 207	9.7
37.0		E84AV□□□3034□□□ ¹⁾	EZAELN3080B371	80.0	125 x 210 x 239	12.5
45.0	E84AV□□□3734□□□ ¹⁾	EZAELN3090B331	90.0	115 x 267 x 201	16.0	
55.0	E84AV□□□4534□□□ ¹⁾	EZAELN3100B301	100	139 x 267 x 201	19.0	

¹⁾ Operation only permitted with mains choke

► Data are valid also for inverters with type code
E84AV□□□□□□□□□□S

Inverter Drives 8400 TopLine

Accessories



Interference suppression

RFI and mains filters are used to ensure compliance with the EMC requirements of European Standard EN 61800-3. This standard defines the EMC requirements for electrical drive system in various categories. **Category C1** applies to public networks (residential areas). Category C1 corresponds to Class B with regard to the limit values of Class B in line with EN 55011.

Category C2 is applicable in industrial premises; use in residential areas is left to the user's discretion. With regard to limit values, Category C2 corresponds to Class A according to EN 55011.





RFI filters

When working with stricter line-bound noise emission requirements, which cannot be met using the radio interference suppression measures integrated in the inverter (C2 up to 25 m shielded motor cable), external filters can be used. The filters can be installed below or next to the inverters.

Available RFI and mains filters

Mode	RFI filter LL (Low Leakage) E84AZESR□□□□LL	RFI filter SD (Short Distance) E84AZESR□□□□SD	RFI filter LD (Long Distance) E84AZESR□□□□LD	Mains filter LD (Long Distance) E84AZESM□□□□LD
Category C1	Up to 5 m shielded motor cable ¹⁾	Up to 25 m shielded motor cable ¹⁾	Up to 50 m shielded motor cable ¹⁾	Up to 50 m shielded motor cable ¹⁾
Category C2		Up to 50 m shielded motor cable ⁻¹⁾	Up to 100 m shielded motor cable ⁻¹⁾	Up to 100 m shielded motor cable ⁻¹⁾
Power range	0.25 to 2.2 kW, 230 V	0.25 to 15 kW	0.25 to 18.5 kW	22 to 45 kW
Features	<ul style="list-style-type: none"> For installation in mobile systems, leakage current < 3.5 mA (up to 5 m shielded motor cable) 	<ul style="list-style-type: none"> Optimised for low leakage current. 	<ul style="list-style-type: none"> 0,25 up to 15 kW: 50 - 100 m at max. 40 °C ambient temperature and max. 4 kHz switching frequency. 	<ul style="list-style-type: none"> Combination of mains choke and RFI filter.

¹⁾   38 - Details on maximum motor cable lengths.

Inverter Drives 8400 TopLine

Accessories



Interference suppression

Operation at rated power

► RFI filter LL (Low Leakage)

Typical motor power 4-pole asynchronous motor	Mains voltage	Product key		Rated current	Dimensions	Mass
		Inverter	RFI filter			
P	U_{AC}			I_N	$h \times b \times t$	m
[kW]	[V]			[A]	[mm]	[kg]
0.25	1 AC 180 ... 264	E84AV□□□2512□□0	E84AZESR3712LL	5.00	212 x 70 x 60	0.8
0.37		E84AV□□□3712□□0				
0.55		E84AV□□□5512□□0	E84AZESR7512LL	9.00	262 x 70 x 60	1.0
0.75		E84AV□□□7512□□0				
1.10		E84AV□□□1122□□0	E84AZESR2222LL	22.0	317 x 70 x 60	1.4
1.50		E84AV□□□1522□□0				
2.20		E84AV□□□2222□□0				

4.5

► RFI filter SD (Short Distance)

Typical motor power 4-pole asynchronous motor	Mains voltage	Product key		Rated current	Dimensions	Mass
		Inverter	RFI filter			
P	U_{AC}			I_N	$h \times b \times t$	m
[kW]	[V]			[A]	[mm]	[kg]
0.25	1 AC 180 ... 264	E84AV□□□2512□□0	E84AZESR3712SD	5.00	212 x 70 x 60	0.8
0.37		E84AV□□□3712□□0				
0.55		E84AV□□□5512□□0	E84AZESR7512SD	9.00	262 x 70 x 60	1.0
0.75		E84AV□□□7512□□0				
1.10		E84AV□□□1122□□0	E84AZESR2222SD	22.0	317 x 70 x 60	1.7
1.50		E84AV□□□1522□□0				
2.20		E84AV□□□2222□□0				
0.37	3 AC 320 ... 550	E84AV□□□3714□□0	E84AZESR7514SD	3.30	262 x 70 x 60	1.1
0.55		E84AV□□□5514□□0				
0.75		E84AV□□□7514□□0	E84AZESR2224SD	7.30	317 x 70 x 60	1.5
1.10		E84AV□□□1124□□0				
1.50		E84AV□□□1524□□0				
2.20		E84AV□□□2224□□0	E84AZESR3024SD	9.80	317 x 70 x 60	1.5
3.00		E84AV□□□3024□□S				
4.00		E84AV□□□3024□□0	E84AZESR5524SD	18.0	306 x 140 x 60	3.1
5.50		E84AV□□□4024□□0				
7.50		E84AV□□□5524□□0				
11.0	E84AV□□□7524□□0	E84AZESR1534SD	29.0	361 x 140 x 60	4.4	
15.0	E84AV□□□1134□□0					
		E84AV□□□1534□□0				

► Data are valid also for inverters with type code
E84AV□□□□□□□□□S

Inverter Drives 8400 TopLine

Accessories



Interference suppression

Operation at rated power

► RFI filter LD (Long Distance)

Typical motor power 4-pole asynchronous motor	Mains voltage U_{AC}	Product key		Rated current I_N	Dimensions h x b x t	Mass						
		Inverter	RFI filter									
P [kW]	[V]			[A]	[mm]	[kg]						
0.25	1 AC 180 ... 264	E84AV□□□2512□□0	E84AZESR3712LD	5.00	212 x 70 x 60	0.8						
0.37		E84AV□□□3712□□0										
0.55		E84AV□□□5512□□0	E84AZESR7512LD									
0.75		E84AV□□□7512□□0										
1.10		E84AV□□□1122□□0	E84AZESR2222LD									
1.50		E84AV□□□1522□□0										
2.20		E84AV□□□2222□□0										
0.37	3 AC 320 ... 550	E84AV□□□3714□□0	E84AZESR7514LD	3.30	262 x 70 x 60	1.1						
0.55		E84AV□□□5514□□0										
0.75		E84AV□□□7514□□0										
1.10		E84AV□□□1124□□0	E84AZESR2224LD									
1.50		E84AV□□□1524□□0										
2.20		E84AV□□□2224□□0										
3.00		E84AV□□□3024□□S					E84AZESR3024LD	9.80				
4.00		E84AV□□□3024□□0	E84AZESR5524LD				18.0	306 x 140 x 60	2.2			
5.50		E84AV□□□4024□□0										
7.50		E84AV□□□5524□□0										
11.0		E84AV□□□7524□□0	E84AZESR1534LD									
15.0		E84AV□□□1134□□0										
15.0		E84AV□□□1534□□0	E84AZESR1834LD							29.0	361 x 140 x 60	3.3
18.5		E84AV□□□1834□□0										
50.4				365 x 205 x 90	7.5							

► Mains filter LD (Long Distance)

Typical motor power 4-pole asynchronous motor	Mains voltage U_{AC}	Product key		Rated current I_N	Dimensions h x b x t	Mass
		Inverter	Mains filter			
P [kW]	[V]			[A]	[mm]	[kg]
18.5	3 AC 320 ... 550	E84AV□□□1834□□0	E84AZESM1834LD	42.0	365 x 205 x 90	7.5
22.0		E84AV□□□2234□□0	E84AZESM2234LD			14.0
30.0		E84AV□□□3034□□0	E84AZESM3034LD			23.0
37.0		E84AV□□□3734□□0	E84AZESM3734LD		519 x 250 x 105	25.0
45.0		E84AV□□□4534□□0	E84AZESM4534LD			30.0

► Data are valid also for inverters with type code
E84AV□□□□□□□□□S

📄 Data sheet on RFI filters
DS_ZB_SR_0001
Available for download at www.lenze.de/dsc

Inverter Drives 8400 TopLine

Accessories



Interference suppression

Operation with increased power output

► RFI filter LL (Low Leakage)

Typical motor power	Mains voltage	Product key		Rated current	Dimensions	Mass
		Inverter	RFI filter			
4-pole asynchronous motor						
P	U_{AC}			I_N	$h \times b \times t$	m
[kW]	[V]			[A]	[mm]	[kg]
0.37	1 AC 180 ... 264	E84AV□□□2512□□0	E84AZESR3712LL	5.00	212 x 70 x 60	0.8
0.55		E84AV□□□3712□□0	E84AZESR7512LL	9.00	262 x 70 x 60	1.0
0.75		E84AV□□□5512□□0				
1.10		E84AV□□□7512□□0	E84AZESR2222LL	22.0	317 x 70 x 60	1.4
1.50		E84AV□□□1122□□0				
2.20		E84AV□□□1522□□0				

► RFI filter SD (Short Distance)

4.5

Typical motor power	Mains voltage	Product key		Rated current	Dimensions	Mass
		Inverter	RFI filter			
4-pole asynchronous motor						
P	U_{AC}			I_N	$h \times b \times t$	m
[kW]	[V]			[A]	[mm]	[kg]
0.37	1 AC 180 ... 264	E84AV□□□2512□□0	E84AZESR3712SD	5.00	212 x 70 x 60	0.8
0.55		E84AV□□□3712□□0	E84AZESR7512SD	9.00	262 x 70 x 60	1.0
0.75		E84AV□□□5512□□0				
1.10		E84AV□□□7512□□0	E84AZESR2222SD	22.0	317 x 70 x 60	1.7
1.50		E84AV□□□1122□□0				
2.20		E84AV□□□1522□□0				
0.55		3 AC 320 ... 550				
0.75	E84AV□□□5514□□0					
1.10	E84AV□□□7514□□0		E84AZESR2224SD	7.30	317 x 70 x 60	1.5
1.50	E84AV□□□1124□□0					
2.20	E84AV□□□1524□□0					
3.00	E84AV□□□2224□□0		E84AZESR5524SD	18.0	306 x 140 x 60	3.1
4.00	E84AV□□□3024□□S					
5.50	E84AV□□□4024□□0					
7.50	E84AV□□□5524□□0					
11.0	E84AV□□□7524□□0		E84AZESR1534SD	29.0	361 x 140 x 60	4.4
15.0	E84AV□□□1134□□0					

► Data are valid also for inverters with type code E84AV□□□□□□□□S

Inverter Drives 8400 TopLine

Accessories



Interference suppression

Operation with increased power output

► RFI filter LD (Long Distance)

Typical motor power 4-pole asynchronous motor	Mains voltage	Product key		Rated current	Dimensions	Mass
		Inverter	RFI filter			
P	U_{AC}			I_N	h x b x t	m
[kW]	[V]			[A]	[mm]	[kg]
0.37	1 AC 180 ... 264	E84AV□□□2512□□0	E84AZESR3712LD	5.00	212 x 70 x 60	0.8
0.55		E84AV□□□3712□□0	E84AZESR7512LD	9.00	262 x 70 x 60	1.0
0.75		E84AV□□□5512□□0				
1.10		E84AV□□□7512□□0	E84AZESR2222LD	22.0	317 x 70 x 60	1.5
1.50		E84AV□□□1122□□0				
2.20		E84AV□□□1522□□0				
0.55	3 AC 320 ... 550	E84AV□□□3714□□0	E84AZESR7514LD	3.30	262 x 70 x 60	1.1
0.75		E84AV□□□5514□□0				
1.10		E84AV□□□7514□□0	E84AZESR2224LD	7.30	317 x 70 x 60	1.4
1.50		E84AV□□□1124□□0				
2.20		E84AV□□□1524□□0				
3.00		E84AV□□□2224□□0	E84AZESR5524LD	18.0	306 x 140 x 60	2.2
4.00		E84AV□□□3024□□0				
5.50		E84AV□□□4024□□0				
7.50		E84AV□□□5524□□0	E84AZESR1534LD	29.0	361 x 140 x 60	3.3
11.0		E84AV□□□7524□□0				
15.0	E84AV□□□1134□□0					

► Mains filter LD (Long Distance)

Typical motor power 4-pole asynchronous motor	Mains voltage	Product key		Rated current	Dimensions	Mass
		Inverter	Mains filter			
P	U_{AC}			I_N	h x b x t	m
[kW]	[V]			[A]	[mm]	[kg]
22.0	3 AC 320 ... 550	E84AV□□□1834□□0	E84AZESM2234LD	42.0	365 x 205 x 90	14.0
30.0		E84AV□□□2234□□0	E84AZESM2234LDN001			18.5
37.0		E84AV□□□3034□□0	E84AZESM3734LD		519 x 250 x 105	25.0
45.0		E84AV□□□3734□□0	E84AZESM4534LD			30.0
55.0		E84AV□□□4534□□0	E84AZESM4534LDN001			32.0

► Data are valid also for inverters with type code
E84AV□□□□□□□□S

📄 Data sheet on RFI filters
DS_ZB_SR_0001
Available for download at www.lenze.de/dsc

Inverter Drives 8400 TopLine

Accessories



Inverter Drives 8400 TopLine

Accessories



Sinusoidal filters

A sinusoidal filter in the motor cable limits the rate of voltage rise and the capacitive charge/discharge currents that occur during inverter operation. In combination with the specified line filter, the EMC requirements of the limit class C2 for conducted noise emissions are still met, even if longer shielded or even unshielded motor cables are used.

Application range:

- Only use a sinusoidal filter with standard asynchronous motors 0 to 550 V
- Operation only with V/f or V/f² characteristic control
- Set the switching frequency permanently to the specified value
- Limit the output frequency of the Inverter Drives 8400 to the specified value



Sinusoidal filter

Operation at rated power

Typical motor power	Mains voltage	Product key				Rated inductance	Switching frequency	Mass
		Inverter	RFI filter	Mains filter	Sinusoidal filter			
4-pole asynchronous motor								
P	U _{AC}					L _N	f _{ch}	m
[kW]	[V]					[mH]	[kHz]	[kg]
0.37	3 AC 320 ... 550	E84AV□□□3714□□□	E84AZESR7514LD		EZS3-004A200	11.0	4 8	4.0
0.55		E84AV□□□5514□□□						
0.75		E84AV□□□7514□□□						
1.10		E84AV□□□1124□□□	E84AZESR2224LD	EZS3-010A200	5.10	5.5		
1.50		E84AV□□□1524□□□						
2.20		E84AV□□□2224□□□	E84AZESR5524LD	EZS3-017A200	3.07	8.5		
3.00		E84AV□□□3024□□□						
4.00		E84AV□□□4024□□□						
5.50		E84AV□□□5524□□□	E84AZESR1534LD	EZS3-024A200	2.50	14.5		
7.50		E84AV□□□7524□□□						
11.0		E84AV□□□1134□□□						
15.0		E84AV□□□1534□□□	E84AZESR1834LD	EZS3-032A200	2.00	19.0		
18.5		E84AV□□□1834□□□						
22.0		E84AV□□□2234□□□						
30.0		E84AV□□□3034□□□	E84AZESM1834LD	EZS3-037A200	1.70	21.0		
37.0		E84AV□□□3734□□□	E84AZESM2234LD	EZS3-048A200	1.20	25.5		
45.0		E84AV□□□4534□□□	E84AZESM3034LD	EZS3-061A200	1.00	33.5		
			E84AZESM3734LD	EZS3-072A200	0.95	37.0		
			E84AZESM4534LD	EZS3-090A200	0.80	53.0		
			EZS3-115A200	0.70	66.0			
					2 4			

► Data are valid also for inverters with type code E84AV□□□□□□□□□S

📄 Data sheet on sinusoidal filters
DS_ZB_EZS3_0001
Available for download at www.lenze.de/dsc

Inverter Drives 8400 TopLine

Accessories



Sinusoidal filters

Operation with increased power output

Typical motor power	Mains voltage	Product key				Rated inductance	Switching frequency	Mass	
		Inverter	RFI filter	Mains filter	Sinusoidal filter				
4-pole asynchronous motor									
P	U _{AC}					L _N	f _{ch}	m	
[kW]	[V]					[mH]	[kHz]	[kg]	
0.55	3 AC 320 ... 550	E84AV□□□□3714□□□□	E84AZESR7514LD		EZS3-010A200	5.10	4	8	5.5
0.75		E84AV□□□□5514□□□□							
1.10		E84AV□□□□7514□□□□	E84AZESR2224LD		EZS3-017A200	3.07	8.5		
1.50		E84AV□□□□1124□□□□							
2.20		E84AV□□□□1524□□□□	E84AZESR5524LD		EZS3-024A200	2.50	14.5		
3.00		E84AV□□□□2224□□□□							
4.00		E84AV□□□□3024□□□□	E84AZESR1534LD		EZS3-037A200	1.70	21.0		
5.50		E84AV□□□□4024□□□□							
7.50		E84AV□□□□5524□□□□		E84AZESM2234LD	EZS3-048A200	1.20	25.5		
11.0		E84AV□□□□7524□□□□							
15.0		E84AV□□□□1134□□□□		E84AZESM2234LDN001	EZS3-061A200	1.00	33.5		
22.0		E84AV□□□□1834□□□□							
30.0		E84AV□□□□2234□□□□		E84AZESM3734LD	EZS3-072A200	0.95	37.0		
37.0		E84AV□□□□3034□□□□							
45.0		E84AV□□□□3734□□□□		E84AZESM4534LD	EZS3-090A200	0.80	53.0		
55.0		E84AV□□□□4534□□□□							
			E84AZESM4534LDN001	EZS3-115A200	0.70	2	4	66.0	

► Data are valid also for inverters with type code E84AV□□□□□□□□□□S





Inverter Drives 8400 TopLine

Accessories



Rated data for power supply modules

► The data is valid for operation at 3/PE AC 400 V.

						
Product key						
Power supply module			E94APNE0104	E94APNE0364	E94APNE1004	E94APNE2454
Rated power						
With mains filter/mains choke	P_N	[kW]	4.90	17.5	48.6	119
Without mains filter/mains choke	P_N	[kW]	3.60	13.0	36.2	88.6
Mains voltage range			3/PE AC 180 V-0 % ... 550 V+0 %, 45 Hz-0 % ... 65 Hz+0 %			
Rated mains current						
	$I_{N,AC}$	[A]	8.0	29.0	82.0	200.0
Rated DC-bus current						
	$I_{N,DC}$	[A]	10.0	36.0	100.0	245.0

4.5

Data for 60 s overload

Max. DC-bus current						
	I_{max}	[A]	15.0	54.0	150.0	368.0
Reduced DC-bus current						
	$I_{red,DC}$	[A]	7.5	27.0	75.0	183.5
Overload time						
	t_{ol}	[s]	120.0			
Recovery time						
	t_{re}	[s]	60.0			
Max. output power¹⁾						
	$P_{max,1}$	[kW]	7.4	26.3	72.9	179.0

Data for 0.5 s overload

Max. short-time DC-bus current						
	I_{max}	[A]	40.0	108.0	200.0	368.0
Reduced DC-bus current						
	$I_{red,DC}$	[A]	7.5	27.0	75.0	183.5
Overload time						
	t_{ol}	[s]	0.5			
Recovery time						
	t_{re}	[s]	4.5			
Max. short-time output power¹⁾						
	$P_{max,2}$	[kW]	19.6	52.5	146.0	357.0

¹⁾ Mains filter required; if no mains filter is installed, the stated values for P_{max} decrease





Inverter Drives 8400 TopLine

Accessories



Rated data for power supply modules

► The data is valid for operation at 3/PE AC 400 V.

						
Product key						
Power supply module			E94APNE0104	E94APNE0364	E94APNE1004	E94APNE2454
Rated power						
With mains filter/mains choke	P_N	[kW]	4.90	17.5	48.6	119
Without mains filter/mains choke	P_N	[kW]	3.60	13.0	36.2	88.6
Rated DC-bus current						
	$I_{N,DC}$	[A]	10.0	36.0	100.0	245.0
Power loss						
	P_V	[W]	55.0	110	230	550
Dimensions						
Height	h	[mm]	350		383	
Height, including fastening	h	[mm]	481		510	
Width	b	[mm]	60	120	210	390
Depth	t	[mm]	288			
Mass						
	m	[kg]	2.6	5.3	13.5	28.5

4.5

Brake chopper rated data

Rated power, Brake chopper						
	P_N	[kW]	2.6	8.7	17.0	30.3
Max. output power, Brake chopper						
	$P_{max,1}$	[kW]	19.5	43.8	105.1	187.7
Running time						
	t_{on}	[s]	1.0			
Recovery time						
	t_{re}	[s]	3.8	2.5	3.1	
Min. brake resistance						
	R_{min}	[Ω]	27.0	12.0	5.0	2.8

Inverter Drives 8400 TopLine

Accessories



Rated data for regenerative power supply modules

- ▶ The data is valid for operation at 3/PE AC 400 V.
- ▶ Mains filter required, please refer to the following pages

						
Product key			E94ARNE0134		E94ARNE0244	
Supply- / regenerative module						
Operating mode			Feed	Feedback	Feed	Feedback
Rated power						
With mains filter/mains choke	P_N	[kW]	15.0	7.50	27.0	13.5
Mains voltage range			3/PE AC 180 V-0 % ... 550 V+0 %, 45 Hz-0 % ... 65 Hz+0 %			
	U_{AC}	[V]				
Rated mains current						
	$I_{N, AC}$	[A]	26.0	13.0	47.0	23.5
Rated DC-bus current						
	$I_{N, DC}$	[A]	32.0	16.0	57.0	29.0

Data for 60 s overload

Max. DC-bus current						
	I_{max}	[A]	48.0	24.0	86.0	44.0
Reduced DC-bus current						
	$I_{red, DC}$	[A]	20.0	9.8	35.0	18.0
Overload time			60.0			
	t_{ol}	[s]				
Recovery time			120.0			
	t_{re}	[s]				
Max. output power						
	$P_{max, 1}$	[kW]	22.4	11.2	40.5	20.2

Data for 0.5 s overload

Max. short-time DC-bus current						
	I_{max}	[A]	96.0	48.0	171.0	87.0
Reduced DC-bus current						
	$I_{red, DC}$	[A]	20.0	9.8	35.0	18.0
Max. short-time output power						
	$P_{max, 2}$	[kW]	44.9	22.4	81.1	40.5
with brake chopper support	$P_{max, 2}$	[kW]		35.1		59.6

Inverter Drives 8400 TopLine

Accessories



Rated data for regenerative power supply modules

- ▶ The data is valid for operation at 3/PE AC 400 V.
- ▶ Mains filter required, please refer to the following pages

Product key			E94ARNE0134		E94ARNE0244	
Supply- / regenerative module						
Operating mode			Feed	Feedback	Feed	Feedback
Rated power						
With mains filter/mains choke	P_N	[kW]	15.0	7.50	27.0	13.5
Rated DC-bus current						
	$I_{N,DC}$	[A]	32.0	16.0	57.0	29.0
Power loss						
	P_V	[W]	150	110	230	190
Dimensions						
Height	h	[mm]	350			
Height, including fastening	h	[mm]	481			
Width	b	[mm]	120			
Depth	t	[mm]	288			
Mass						
	m	[kg]	6.0			

4.5

Brake chopper rated data

Rated power, Brake chopper				
	P_N	[kW]	4.7	9.3
Max. output power, Brake chopper				
	$P_{max,1}$	[kW]	19.5	29.2
Running time				
	t_{on}	[s]	1.0	
Recovery time				
	t_{re}	[s]	4.2	3.9
Min. brake resistance				
	R_{min}	[Ω]	27.0	18.0

Inverter Drives 8400 TopLine

Accessories



Control connections

Mode	Power supply modules	Regenerative power supply modules
Analog inputs		
Number		2
Resolution		11 bits + sign
Value range		+/- 10V 1 x switchable 20 mA
Analog outputs		
Number		2
Resolution		10 bits + sign
Value range		+/- 10V max. 2 mA
Digital inputs		
Number	1 Permanently configured	8
Switching level	PLC (IEC 61131-2)	
Max. input current	8 mA	
Digital outputs		
Number	4 fest konfiguriert	4
Switching level	PLC (IEC 61131-2)	
Max. output current	50 mA per output	
Load capacity	>480 Ω at 24 V	
External DC supply		
Rated voltage	24 V in accordance with IEC 61131-2	
Voltage range	19.2 ... 28.8 V, max. residual ripple ± 5%	
Current	Approx. 1.4 A during operation, max. 4 A starting current for 100 ms	Approx. 1.2 A during operation, max. 3 A starting current for 100 ms ¹⁾
Interfaces		
CANopen		Integrated
Extensions		Via slot MXI 2: extension 2 Via slot MXI 1: extension 1
State bus		Integrated
Memory		Slot MMI
Safety engineering		Slot MSI
Drive interface		
Resolver input		Integrated (no function)
Mains synchronisation input		Integrated Sub-D, 15-pin

¹⁾ The supply to the control electronics comes from the mains voltage. Alternatively, it can be provided by a 24 V supply that is independent of the mains (available as an option).

Inverter Drives 8400 TopLine

Accessories



Brake resistors of the regenerative power supply modules

Assignment of brake resistors to the supply and regenerative power supply modules is shown in the tables below.



Brake resistor 27 ohms

Brake resistors for power supply modules

Rated power	Mains voltage	Product key		Rated resistance	Rated power	Thermal capacity	Dimensions	Mass
Without mains filter/mains choke		Power supply module	Brake resistor					
P_N	U_{AC}			R_N	P_N	C_{th}	$h \times b \times t$	m
[kW]	[V]			[Ω]	[kW]	[KWs]	[mm]	[kg]
3.60	3 AC 180 ... 550 ¹⁾	E94APNE0104	ERBP027R200W	27.0	200.0	30.0	320 x 41 x 122	1.0
			ERBS027R600W		600.0	90.0	550 x 110 x 105	3.1
			ERBS027R01K2		1200.0	180	1020 x 110 x 105	5.6
13.0		E94APNE0364	ERBG012R01K9	12.0	1900.0	285	486 x 236 x 302	13.0
			ERBG012R05K2		5200.0	750	486 x 426 x 302	28.0
36.2		E94APNE1004	ERBG005R02K6	5.0	2600.0	390	486 x 326 x 302	12.6
88.6		E94APNE2454	ERBG028D04K1	2.8	4100.0	615	486 x 426 x 302	12.8

¹⁾ For 230 V mains voltage a different brake resistor assignment applies.

Brake resistors for regenerative power supply modules

Rated power	Mains voltage	Product key		Rated resistance	Rated power	Thermal capacity	Dimensions	Mass
With mains filter/mains choke		Supply- / regenerative module	Brake resistor					
P_N	U_{AC}			R_N	P_N	C_{th}	$h \times b \times t$	m
[kW]	[V]			[Ω]	[kW]	[KWs]	[mm]	[kg]
15.0	3 AC 180 ... 550 ²⁾	E94ARNE0134	ERBP027R200W	27.0	200.0	30.0	320 x 41 x 122	1.0
			ERBS027R600W		600.0	90.0	550 x 110 x 105	3.1
			ERBS027R01K2		1200.0	180	1020 x 110 x 105	5.6
27.0		E94ARNE0244	ERBP018R300W	18.0	300.0	30.0	240 x 41 x 122	1.4
			ERBS018R01K2		1200.0	180	1020 x 110 x 105	5.6
			ERBS018R02K8		2800.0	420	1110 x 200 x 105	12.0

²⁾ For 230 V mains voltage a different brake resistor assignment applies.

 Data sheet on brake resistors
DS_9400_0002
 Available for download at www.lenze.de/dsc

Inverter Drives 8400 TopLine

Accessories



Interference suppression of the regenerative power supply modules

RFI filters and mains filters enable compliance with the interference voltage categories of the European standard EN 61800-3. There a distinction is drawn between category C1 and category C2.

Category C1 describes the use on public supply networks.

Category C2 describes the use of drives which are intended to be used for industrial purposes in areas also comprising residential areas.

For Multi Drives external filters must be used to comply with the EMC Directive.



RFI filter, can be mounted beside the power supply module

RFI filters

RFI filters are primarily capacitive accessory components which can be connected directly upstream from the power supply modules. This measure enables compliance with the corresponding conducted noise emission requirements according to EN 61800-3.

4.5

Rated power	Mains voltage	Product key		Rated current	Power loss	Max. cable length	Dimensions	Mass
		Power supply module	RFI filter					
Without mains filter/mains choke						Reference group C2		
P_N	U_{AC}			I_N	P_V	l_{max}	$h \times b \times t$	m
[kW]	[V]			[A]	[kW]	[m]	[mm]	[kg]
3.60	3 AC 180 ... 550	E94APNE0104	E94AZRP0084	8.00	20.0	6 axes of 10 m each	485 x 60 x 261	4.2
13.0		E94APNE0364	E94AZRP0294	29.0	50.0			4.5
36.2		E94APNE1004	E94AZRP0824	82.0	80.0		490 x 209 x 272	18.5
88.6		E94APNE2454	E94AZRP2004	200	150			20.5

▶ Data sheet on RFI filters
DS_9400_0003

Available for download at www.lenze.com/dsc

Inverter Drives 8400 TopLine

Accessories



Interference suppression of the regenerative power supply modules

Mains filters

A mains filter is a combination of mains choke and RFI filter in a single housing. It reduces line-bound noise emission into the mains, thus ensuring that the line-bound interference voltage is reduced to a permissible level according to EN61800-3.



Mains filter, can be mounted beside the power supply modules (right) or the regenerative power supply modules (left)

Mains filters for power supply modules

Rated power	Mains voltage	Product key		Rated current	Voltage drop	Max. cable length	Dimensions	Mass
		Power supply module	Mains filter					
With mains filter/mains choke						Reference group C2		
P_N	U_{AC}			I_N	U	I_{max}	$h \times b \times t$	m
[kW]	[V]			[A]	[V]	[m]	[mm]	[kg]
4.90	3 AC 180 ... 550	E94APNE0104	E94AZMP0084	8.00	10.0	10 axes of 50 m each	485 x 90 x 261	8.6
17.5		E94APNE0364	E94AZMP0294	29.0	7.3		485 x 120 x 261	16.5
48.6		E94APNE1004	E94AZMP0824 ¹⁾	82.0	6.4		490 x 270 x 272	29.0
119		E94APNE2454	E94AZMP2004 ¹⁾	200	6.3		490 x 330 x 272	52.0

¹⁾ External 24 V supply from a safely separated power supply unit (SELV/PELV) required for integrated fan.

Mains filters for regenerative power supply modules

Rated power	Mains voltage	Product key		Rated current	Voltage drop	Max. cable length	Dimensions	Mass
		Supply- / regenerative module	Mains filter					
With mains filter/mains choke						Reference group C2		
P_N	U_{AC}			I_N	U	I_{max}	$h \times b \times t$	m
[kW]	[V]			[A]	[V]	[m]	[mm]	[kg]
15.0	3 AC 180 ... 550	E94ARNE0134	E94AZMR0264SDB ²⁾	26.0	6.3	6 axes of 10 m each	485 x 149 x 272	25.0
			E94AZMR0264LDB ²⁾			10 axes of 50 m each		26.0
27.0		E94ARNE0244	E94AZMR0474SDB ²⁾	47.0	6.2	6 axes of 10 m each	485 x 209 x 272	36.0
			E94AZMR0474LDB ²⁾			10 axes of 50 m each		37.0

²⁾ External 24 V supply through safely separated power supply unit (SELV/PELV) required for integrated mains voltage recording.

Data sheet on mains filters
DS_9400_0004
Available for download at www.lenze.de/dsc

Inverter Drives 8400 TopLine

Accessories



DC input module

Via a DC input module, an axis module interconnection can be supplied with power from a central DC source (power supply module, Single Drive axis modules, Multi Drive axis modules). This is required for example if a drive system with a multi-level structure installed in a control cabinet is to be supplied via a central DC power supply unit. The rated current of the DC input module is defined to be 100 A (DC). The DC input module can be connected at the top or bottom, offering great flexibility with regard to integration into the system wiring. This provides an ideal way of connecting multi-row axis modules in particular.



DC input module
100 A

Mode	Product key	Dimensions	Mass
	Input module		
		h x b x t	m
		[mm]	[kg]
DC input module 100 A	E94AZEX100	422 x 60 x 95	0.9

4.5

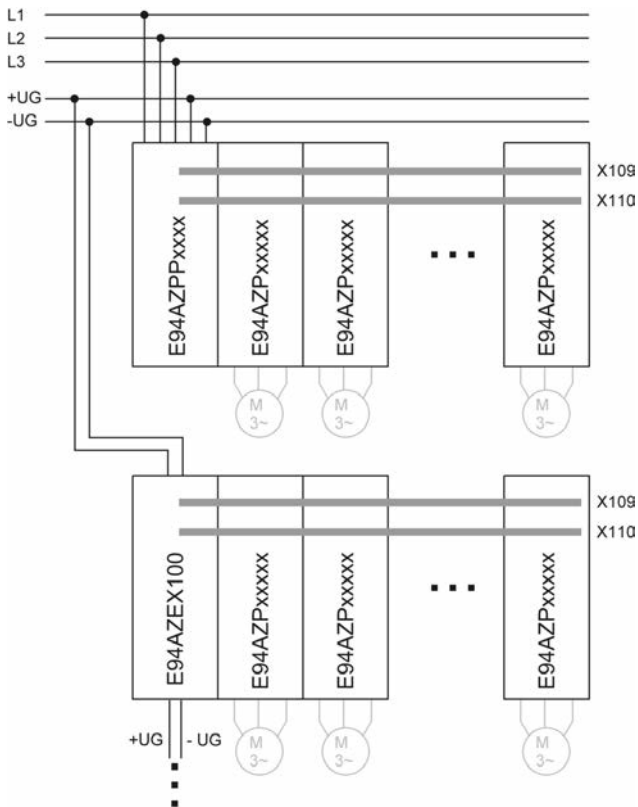

Wiring example for multi-row mounting of axis modules

Inverter Drives 8400 TopLine

Accessories



DC-bus connection

The Inverter Drives 8400 can be operated in a DC-bus connection. The 400 V devices have a direct connection for this.

The components listed here are used to interconnect the individual devices for operation with or without a regenerative power supply module. With a DC-bus connection, energy can be exchanged between the individual devices. This makes particular sense with cyclic operation of multiple devices.

The design of a DC-bus connection requires extremely precise dimensioning of the devices' energy requirements among one another. Lenze Sales is happy to advise you here to ensure the most energy-efficient drive dimensioning. The components listed here form the basis for this.

- ▶ Two DC fuses are always required.
- ▶ The fuse holders EFH10005 and EFH10004 are single-pole, while the holders EFH20005 and EFH20007 are 2-pole.
- ▶ The DC fuses are not UL-approved
- ▶ Please consult Lenze Sales to ensure the right dimensioning.

Components for DC-bus connection

Product key	Rated current	Design
DC fuses		
	I_N	
	[A]	
EFSGR0060AYHN	6.00	14x51 without indicator
EFSGR0100AYHN	10.0	
EFSGR0160AYHN	16.0	
EFSGR0200AYHN	20.0	
EFSGR0250AYHN	25.0	
EFSGR0320AYHN	32.0	
EFSGR0400AYHN	40.0	
EFSGR0060AYHK	6.00	14x51 with indicator
EFSGR0100AYHK	10.0	
EFSGR0160AYHK	16.0	
EFSGR0200AYHK	20.0	
EFSGR0250AYHK	25.0	
EFSGR0320AYHK	32.0	
EFSGR0400AYHK	40.0	

Product key	Rated current	Design
DC fuses		
	I_N	
	[A]	
EFSGR0120AYIN	12.0	22x58 without indicator
EFSGR0160AYIN	16.0	
EFSGR0200AYIN	20.0	
EFSGR0250AYIN	25.0	
EFSGR0320AYIN	32.0	
EFSGR0400AYIN	40.0	
EFSGR0500AYIN	50.0	
EFSGR0800AYIN	80.0	
EFSGR0120AYIK	12.0	22x58 with indicator
EFSGR0160AYIK	16.0	
EFSGR0200AYIK	20.0	
EFSGR0250AYIK	25.0	
EFSGR0320AYIK	32.0	
EFSGR0400AYIK	40.0	
EFSGR0500AYIK	50.0	
EFSGR0800AYIK	80.0	

4.5

Mode	Features	Product key
DC busbar	• Busbar system 14 x 51 • DC busbar length 1m, cross-section 25 mm ²	EWZ0036
	• Busbar system 22 x 58 • DC busbar length 1m, cross-section 25 mm ²	EWZ0037
End cap	• End caps for DC busbar (packaging unit 10 pcs)	EWZ0038
Terminal	• Single-pole terminal for internal supply	EWZ0039

Inverter Drives 8400 TopLine

Accessories



DC-bus connection

DC fuses size 14 x 51 mm

Typical motor power 4-pole asynchronous motor	Mains voltage U_{AC}	Product key				
		Inverter	DC fuses			
P [kW]	[V]					
0.37	3 AC 320 ... 550	E84AV□□□3714□□0	EFSGR0060AYHN	EFH20005	EFSGR0060AYHK	EFH10005
0.55		E84AV□□□5514□□0				
0.75		E84AV□□□7514□□0				
1.10		E84AV□□□1124□□0	EFSGR0100AYHN		EFSGR0100AYHK	
1.50		E84AV□□□1524□□0				
2.20		E84AV□□□2224□□0	EFSGR0160AYHN		EFSGR0160AYHK	
3.00		E84AV□□□3024□□0	EFSGR0200AYHN		EFSGR0200AYHK	
4.00		E84AV□□□4024□□0	EFSGR0250AYHN		EFSGR0250AYHK	
5.50		E84AV□□□5524□□0	EFSGR0320AYHN		EFSGR0320AYHK	
7.50		E84AV□□□7524□□0	EFSGR0400AYHN		EFSGR0400AYHK	
11.0		E84AV□□□1134□□0				
15.0		E84AV□□□1534□□0				

4.5

DC fuses size 22 x 58 mm

Typical motor power 4-pole asynchronous motor	Mains voltage U_{AC}	Product key				
		Inverter	DC fuses			
P [kW]	[V]					
0.37	3 AC 320 ... 550	E84AV□□□3714□□0	EFSGR0120AYIN	EFH20007	EFSGR0120AYIK	EFH10004
0.55		E84AV□□□5514□□0				
0.75		E84AV□□□7514□□0				
1.10		E84AV□□□1124□□0	EFSGR0160AYIN		EFSGR0160AYIK	
1.50		E84AV□□□1524□□0				
2.20		E84AV□□□2224□□0	EFSGR0200AYIN		EFSGR0200AYIK	
3.00		E84AV□□□3024□□0	EFSGR0250AYIN		EFSGR0250AYIK	
4.00		E84AV□□□4024□□0	EFSGR0320AYIN		EFSGR0320AYIK	
5.50		E84AV□□□5524□□0	EFSGR0400AYIN		EFSGR0400AYIK	
7.50		E84AV□□□7524□□0	EFSGR0500AYIN		EFSGR0500AYIK	
11.0		E84AV□□□1134□□0	EFSGR0800AYIN		EFSGR0800AYIK	
15.0		E84AV□□□1534□□0				

Inverter Drives 8400 TopLine

Accessories



24 V power supply unit

External power supply units are available for supplying the control electronics of the 8400 StateLine, HighLine or TopLine. With an external supply, the inverters can be parameterised and diagnosed while the mains input is deenergised.



24 V power supply unit

Rated data

Product key			EZV1200-000	EZV2400-000	EZV4800-000	EZV1200-001	EZV2400-001	EZV4800-001
Rated voltage			230			400		
AC	$U_{N,AC}$	[V]						
Input voltage			AC 85 ... 264 DC 90 ... 350			AC 320 ... 575 DC 450 ... 800		
	U_{in}	[V]						
Rated mains current			0.8	1.2	2.3	0.3	0.6	1.0
	$I_{N,AC}$	[A]						
Output voltage			DC 22.5 ... 28.5					
	U_{out}	[V]						
Rated output current			5.0	10.0	20.0	5.0	10.0	20.0
	$I_{N,out}$	[A]						
Dimensions								
Height	h	[mm]	130					
Width	b	[mm]	55	85	157	73	85	160
Depth	t	[mm]	125					
Mass			0.8	1.2	2.5	1.0	1.1	1.9
	m	[kg]						

4.5

Brake switch

The brake switch consists of a rectifier and an electronic circuit breaker for the switching of an electromechanical brake switch. The brake switch is mounted on the control cabinet plate by means of two screws. Control is performed using a digital output on the inverter.



Brake switch

Mode	Features	Product key
Half-wave rectification	<ul style="list-style-type: none"> Input voltage: AC 320 ... 550 V Output voltage: DC 180 V (at AC 400 V), DC 225 V (at AC 500 V) Max. brake current: DC 0.61 A Enclosure: IP00 	E82ZWBRE
Bridge rectification	<ul style="list-style-type: none"> Input voltage: AC 180 ... 317 V Output voltage: DC 205 V (at AC 230 V) Max. brake current: DC 0.54 A Enclosure: IP00 	E82ZWBREB

Data sheet on E82ZWBRE brake switch
DS_Brake_8400_0001
 Available for download at www.lenze.de/dsc

Data sheet on E82ZWBREB brake switch
DS_Brake_8400_0002
 Available for download at www.lenze.de/dsc

Inverter Drives 8400 TopLine

Accessories



USB diagnostic adapter

The operation, parameter setting and diagnostics of the Inverter Drives 8400 and the Servo Drives 9400 via the L-force diagnostics is made with the keypad X400 or a PC. The connection of a PC can be made via a USB interface and the USB diagnostic adapter.

For connecting the USB diagnostic adapter with the L-force diagnostics interface (DIAG) at the inverter, three different connecting cables are separately available in the lengths 2.5 m, 5 m and 10 m. The connection can be established during operation. The engineering tools EASY Starter or Engineer can be used to carry out the operation, parameter setting or diagnostics of the inverters. Both tools have simple intuitive surfaces. This enables a quick and easy commissioning.

Optionally to the USB diagnostic adapter, the PC system bus adapter can be used. For this purpose, a CANopen interface must be available at the inverter.



USB diagnostic adapter incl. connecting cable to the PC

4.5

- The engineering tools EASY Starter or Engineer are used for operation, parameter setting and diagnostics of the inverters.

Mode		Features	Product key
USB diagnostic adapter		<ul style="list-style-type: none"> • Input-side voltage supply via USB connection on PC • Output-side voltage supply via inverter's diagnostic interface • Diagnostic LEDs • Electrical isolation of PC and inverter • Hot-pluggable 	E94AZCUS

Connecting cables for USB diagnostic adapter

Mode	Features	Product key
Connecting cable for USB diagnostic adapter	• Length: 2.5 m	EWL0070
	• Length: 5 m	EWL0071
	• Length: 10 m	EWL0072

Inverter Drives 8400 TopLine

Accessories



X400 keypad

As an alternative to the PC, the X400 keypad can be used for local operation, parameter setting or diagnostics. The X400 keypad plugs into the L-force diagnostics interface (DIAG) on the front of the inverter.



X400 keypad

Mode		Features	Slot	Product key
X400 keypad		<ul style="list-style-type: none">• Menu navigation• Graphics display with background lightning for clear presentation of information• 4 navigation keys, 2 context-sensitive keys• Adjustable RUN/STOP function	DIAG	EZAEBK1001

- ▶ The Inverter Drives 8400 can be ordered with a plug-in keypad already installed. If you would like to order the products in this complete form, please add the inverter product key as follows when placing your order: E84AV to X-XXXXXX
- ▶ The product key with the supplement for the applied module is provided in our sales documents. This information is not part of the nameplate of the device.

4.5

X400 diagnosis terminal

Mode		Features	Slot	Product key
X400 diagnosis terminal		<ul style="list-style-type: none">• X400 keypad in a robust housing• Also suitable for installation in the control cabinet door• incl. 2.5 m cable• IP20 enclosure, IP65 for control cabinet installation on front face	DIAG	EZAEBK2001

Inverter Drives 8400 TopLine



Accessories

PC system bus adapter

Instead of a PC, the 8400 inverter drives can alternatively be operated, parameterised and diagnosed using the CANopen interface and a PC system bus adapter, which is required instead of a USB diagnostic adapter. This adapter plugs into the parallel interface or the USB connection of the PC. The corresponding drivers are installed automatically. Depending on the version, the adapter is supplied with voltage via the DIN, PS2 or USB connection of the PC. The CANopen interface is integrated or available with a variant (BaseLine C).

Advantage:

- Operation, parameterisation and diagnostics in parallel with the keypad
- In interconnected systems, multiple inverters can be addressed simultaneously from one point (remote parameterisation via CANopen)



EMF2173IBV003 adapter

Mode	Features	Product key
PC system bus adapter	• Voltage supply via DIN port on PC	EMF2173IB
	• Voltage supply via PS2 connection on PC	EMF2173IBV002
	• Voltage supply via PS2 connection on PC • Electrical isolation from the bus	EMF2173IBV003
	• Voltage supply via USB port on PC • Electrical isolation from the bus	EMF2177IB

4.5

Shield mounting

A shield mounting is used to connect the motor cable shield on the inverter's shield connection.

Mode	Features	Product key
Metal cable tie	• Cable diameter: 8...30 mm • Packaging unit: 50 items	EZAMBKBM
Fixing clip	• Cable diameter: 4...10 mm • Packaging unit: 20 items	EZAMBHXM007/M
Wire clamp	• Cable diameter: 4...15 mm • Packaging unit: 10 items	EZAMBHXM006/M
	• Cable diameter: 10...20 mm • Packaging unit: 10 items	EZAMBHXM003/M
	• Cable diameter: 15...28 mm • Packaging unit: 10 items	EZAMBHXM004/M
	• Cable diameter: 20...37 mm • Packaging unit: 10 items	EZAMBHXM005/M

Inverter Drives 8400 TopLine

Accessories



Terminal strips

All connections are equipped with pluggable connectors, with power connections up to 15 kW. These pluggable connectors are available separately for service purposes or if cable harnesses need to be physically separated.

► Power connections

Product key	Terminal strip	Features	Product key	Terminal strip	Features	Product key
Inverter						
E84AV□□□2512□□0	X100	<ul style="list-style-type: none"> • Connection: mains • Packaging unit: 10 items 	E84AZEVS001X100/M	X105	<ul style="list-style-type: none"> • Connection: motor • Packaging unit: 5 items 	E84AZEVS010X105/M
E84AV□□□3712□□0						
E84AV□□□5512□□0			E84AZEVS003X100/M			
E84AV□□□7512□□0						
E84AV□□□1122□□0			E84AZEVS005X100/M			
E84AV□□□1522□□0						
E84AV□□□2222□□0		E84AZEVS012X105/M				
E84AV□□□3714□□0			E84AZEVS011X105/M			
E84AV□□□5514□□0		E84AZEVS012X105/M				
E84AV□□□7514□□0			E84AZEVS011X105/M			
E84AV□□□1124□□0		E84AZEVS012X105/M				
E84AV□□□1524□□0			E84AZEVS011X105/M			
E84AV□□□2224□□0		E84AZEVS012X105/M				
E84AV□□□3024□□S			E84AZEVS011X105/M			
E84AV□□□3024□□0		E84AZEVS012X105/M				
E84AV□□□4024□□0			E84AZEVS011X105/M			
E84AV□□□5524□□0		E84AZEVS012X105/M				
E84AV□□□7524□□0			E84AZEVS011X105/M			
E84AV□□□1134□□0	E84AZEVS012X105/M					
E84AV□□□1534□□0						

► Control connections

Terminal strip	Features	Product key
X1	<ul style="list-style-type: none"> • Connection: CANopen • Packaging unit: 10 items 	E84AZEVS040X001/M
X3	<ul style="list-style-type: none"> • Connection: analog inputs and outputs • Packaging unit: 5 items 	E84AZEVS060X003/M
X4	<ul style="list-style-type: none"> • Connection: digital outputs • Packaging unit: 10 items 	E84AZEVS060X004/M
X5	<ul style="list-style-type: none"> • Connection: digital inputs • Packaging unit: 5 items 	E84AZEVS060X005/M
X10	<ul style="list-style-type: none"> • Connection: axis bus • Packaging unit: 10 items 	E84AZEVS060X010/M
X80	<ul style="list-style-type: none"> • Connection: safety engineering • Packaging unit: 10 items 	E84AZEVS070X080/M
X101	<ul style="list-style-type: none"> • Connection: relay • Packaging unit: 10 items 	E84AZEVS020X101/M
X106	<ul style="list-style-type: none"> • Connection: PTC • Packaging unit: 10 items 	E84AZEVS030X106/M
X107	<ul style="list-style-type: none"> • Connection: 2.5 A digital output • Packaging unit: 10 items 	E84AZEVS060X107/M

Inverter Drives 8400 TopLine

Accessories



Setpoint potentiometer

The setpoint selection (e.g. speed) can be made via an external potentiometer.

The setpoint potentiometer is connected to the inverter's analog input terminals. A scale and a rotary knob are also available.



Setpoint potentiometer with scale and rotary knob

Mode	Product key
10 kOhm / 1 Watt potentiometer	ERPD0010K0001W
Rotary knob, 36 mm diameter	ERZ0001
Scale 0 ... 100%, 62 mm diameter	ERZ0002

Inverters

Servo-Inverter i700

5 to 64 A



Servo-Inverter i700

Contents



General information		Product key	4.6 - 4
		Equipment	4.6 - 5
		List of abbreviations	4.6 - 6
		Generation Easy for multi-axis applications	4.6 - 7
		Functions and features	4.6 - 8
		Operating modes	4.6 - 9
		Dimensioning of a multi-axis system	4.6 - 10
Technical data		Standards and operating conditions	4.6 - 13
		Rated data for single axes	4.6 - 14
		Rated data for double axes	4.6 - 16
		Rated data for power supply modules	4.6 - 18
		"Cold plate" design	4.6 - 20
		Push-through technique design	4.6 - 22
Interfaces		Mains connection	4.6 - 25
		Motor connection	4.6 - 26
		Connection diagrams	4.6 - 28
		Control connections	4.6 - 30
		Safety system (STO)	4.6 - 32
		EtherCAT® communication	4.6 - 33
Accessories	Power supply modules	Brake resistors for power supply modules	4.6 - 34
		Mains chokes for power supply modules	4.6 - 35
		Interference suppression of power supply modules	4.6 - 36
		24 V power supply unit	4.6 - 38
		Installation sets for Servo-Inverter i700	4.6 - 38

Servo-Inverter i700

General information



Product key

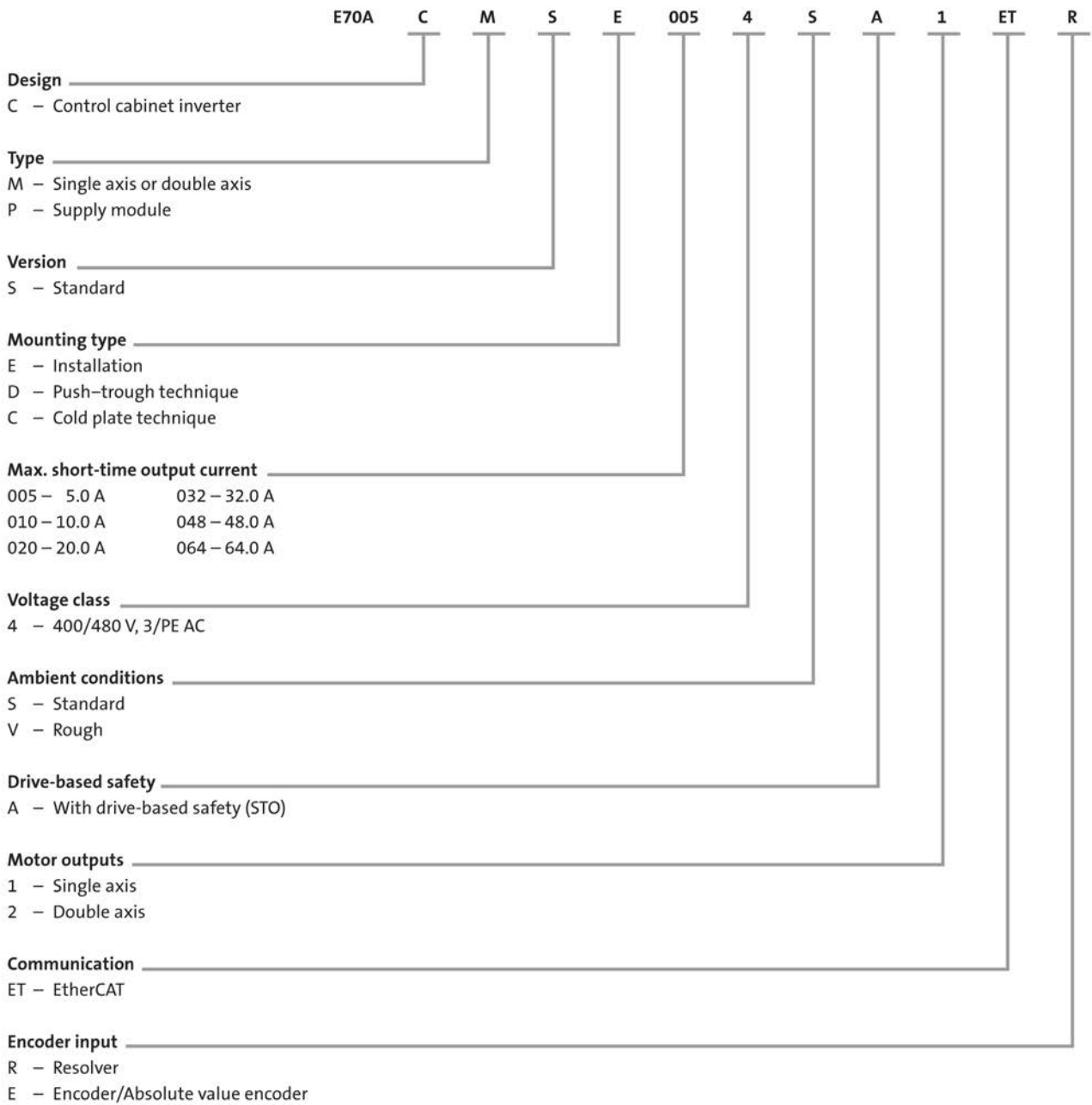

4.6

Servo-Inverter i700

General information



List of abbreviations

b	[mm]	Dimensions
C _{th}	[KW _s]	Thermal capacity
f _{ch}	[kHz]	Rated switching frequency
h	[mm]	Dimensions
I _{N, out}	[A]	Rated output current
I _{N, AC}	[A]	Rated mains current
m	[kg]	Mass
n _{max}	[r/min]	Max. speed
P	[kW]	Typical motor power
P _V	[kW]	Power loss
P _N	[kW]	Rated power
R _N	[Ω]	Rated resistance
t	[mm]	Dimensions
U _{AC}	[V]	Mains voltage
U _{DC}	[V]	DC supply
U _{N, AC}	[V]	Rated voltage
U _{out}	[V]	Max. output voltage

ASM	Asynchronous motor
DIAG	Slot for diagnostic adapter
DIN	Deutsches Institut für Normung e.V.
EN	European standard
EN 60529	Degrees of protection provided by enclosures (IP code)
EN 60721-3	Classification of environmental conditions; Part 3: Classes of environmental parameters and their limit values
EN 61800-3	Electrical variable speed drives Part 3: EMC requirements including special test methods
IEC	International Electrotechnical Commission
IEC 61508	Functional safety of electrical/electronic/programmable electronic safety-related systems
IM	International Mounting Code
IP	International Protection Code
MCI	Slot for communication module (module communication interface)
NEMA	National Electrical Manufacturers Association
UL	Underwriters Laboratory Listed Product
UR	Underwriters Laboratory Recognized Product
VDE	Verband deutscher Elektrotechniker (Association of German Electrical Engineers)

Servo-Inverter i700

General information



Generation Easy for multi-axis applications

The innovative Servo-Inverter i700 for central motion control is characterised by its compact and highly flexible design. Dual axes keep the drive size to a minimum, dynamic motor control makes it suitable for use in a wide range of applications. Drive integration, commissioning and maintenance have been substantially simplified thanks to its installation concept and easy engineering.

Highlights:

- Easy to use: from installation to service
- Compact: both in size and connection system
- Flexible: motor control for synchronous and asynchronous motors
- High performance, e. g. with real-time EtherCAT® bus system

i700 – in use

Powerful central motion control of demanding machine tasks is best achieved with our Controller-based Automation. The Servo-Inverter i700 for multiaxis application can drive all centrally controlled motors in your machine module – from three-phase AC motor to servo motor.

i700 features:

- Multi-axis system
- Single and double axes
- Power supply modules
- DC-bus connection via busbar system
- Pluggable connection system
- Automatic parameter/firmware download via the control system
- Motor control:
 - Servo with field weakening and torque pre-control
 - V/f control for standard asynchronous motors without encoder
- Scalable safety functions
- 3 cooling methods: standard panel-mount, cold plate technique, push-through technique

4.6



Servo-Inverter i700

General information



Functions and features

The Servo-Inverter i700 can be directly implemented into the Controller-based Automation applications via the integrated EtherCAT® interface. The interaction of the different Lenze controllers provide for a high number of sophisticated L-force Motion applications.

The speed and position control modes are directly executed in the servo inverter which ensures very short cycle times (0.25 ms). The selection of the right control mode for the application is determined via the application in the Controller. The "Controller-based Automation" chapter summarises which controller optimally solves the individual applications together with the i700.

Mode	Servo-Inverter i700
Control types, motor control	
Field-oriented servo control (SC)	For synchronous servo motors, asynchronous servo motors and three-phase asynchronous motors
V/f control (VFCplus)	For three-phase AC motors and asynchronous servo motor (linear or square-law)
Basic functions	
	Brake management for brake control with low rate of wear PID controller
Operating modes to CiA 402	Velocity mode (VL) - non-cyclic velocity setpoint Cyclic synchronous position (csp) - cyclic position setpoint Cyclic synchronous velocity (csv) - cyclic velocity setpoint Cyclic synchronous torque (cst) - cyclic torque setpoint
Overload behaviour	
	200% maximum current (with regard to 4kHz rated current)
Functions with FAST Application Software	
	Comprehensive library of function and technology modules e.g. for positioning, cam functions, electrical shaft etc.
Monitoring and protective measures	
	Overload Short circuit Earth fault Overvoltage Undervoltage DC-bus voltage Motor phase failure Overcurrent I ² x t-Motor monitoring Overtemperature Motor overtemperature Brake chopper, brake resistance Motor stalling
Diagnostics	
	Axis modules: Error codes to CiA 402 Power supply modules: Status message via 2 digital outputs Oscilloscope functions
Status display	2 LEDs
Braking operation	
Brake chopper	Integrated in power supply module
Brake resistor	External
Mounting conditions	
Mounting type	Installation Cold plate technique Push-through technique
Mounting place	In the control cabinet
Mounting position	Vertical
Free spaces	At the top: minimum 90 mm Side-by-side mounting without any clearance At the bottom: minimum 70 mm

Servo-Inverter i700

General information



Operating modes

Overcurrent operation

Axis modules and power supply modules

Power supply modules and axis modules can be operated with higher currents beyond the rated current if this overcurrent is only active for a limited operating time. Within the efficiency cycles, the overcurrent can flow for a certain period of time if afterwards an accordingly long recovery phase takes place afterwards. Two efficiency cycles of 15 s [1] in red and 180 s [2] in blue are defined.

- 15-s cycle
 - 3 s (T_1) load period with peak current [A] (200 %)
 - 12 s (T_2) recovery time with limited current [B] (75 %)
- 180-s cycle
 - 60 s (T_3) load period with peak current [C] (150 %)
 - 120 s (T_4) recovery time with limited current [D] (75 %)

A load period with peak current must be followed by a recovery time. In the recovery time, the current must not exceed the given value.

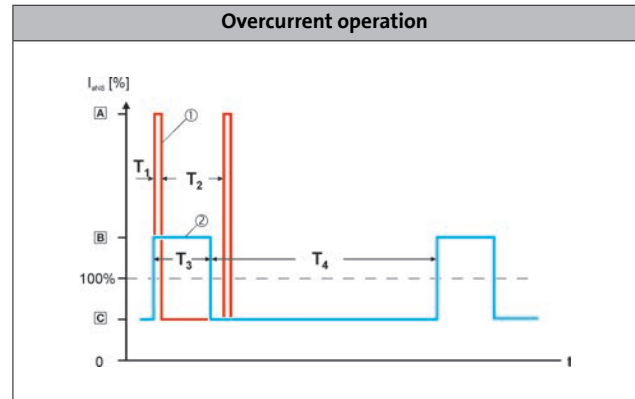

- From a maximum device current of 32 A, the following restriction applies:
With field frequencies lower than 5 Hz, the cycle time of the short time behaviour is reduced from 15 s to 3 s.



Dimensioning of a multi-axis system

Drive dimensioning of multi-axis systems with Servo-Inverters i700 can be easily carried out using the DSD (Drive Solution Designer) engineering tool. This tool can be downloaded from the Lenze homepage (<http://www.lenze.com/download/software-downloads>). It considers various, frequently recurring applications, the ambient conditions and the entire mechatronic system and their operating mode as for instance coordinated or uncoordinated multi-axis operation with energy exchange in the DC-bus system. It provides comprehensible dimensioning protocols and an Energy Performance Certificate for the axes and for the multi-axis system. The Energy Performance Certificate clearly displays the energy efficiency of all drive components under the given operation modes and provides potential for energy optimisations for entire plants.

Functions and features

Mode	Engineering Tool DSD
Applications	Comprehensive applications as for instance linear and rotating drives, positioning-, wheel, hoist and synchronous drives, winders, pumps, fans, ...
Components	Inverter Motors (brake, feedback) Geared motors Power supply modules
Check of components and drive system	Monitoring functions of the inverters Maximum limits of the components Product data in the applications Consideration and check of the entire drive system Limit loads (electrical/mechanical) M-n characteristic fields and system checks Possible combinations of the drive components Losses and energy efficiency
Optimisation and evaluation	Energy consumption of the components and of the application Energy exchange in multi-axis applications Representation of working points, e.g. as characteristic
Presentation of the result	Evaluation of the dimensioning Representation of energy consumption Logging of dimensioning Creating CAD data
Basic functions	Metric and imperial unit systems Intuitive interfaces with simple dialogs Comprehensive online help with physical basics and overviews Fast and easy drive dimensioning and product configuration Editor for the motion sequence Creating alternative solutions with comparison operations

Servo-Inverter i700

General information



Dimensioning of a multi-axis system

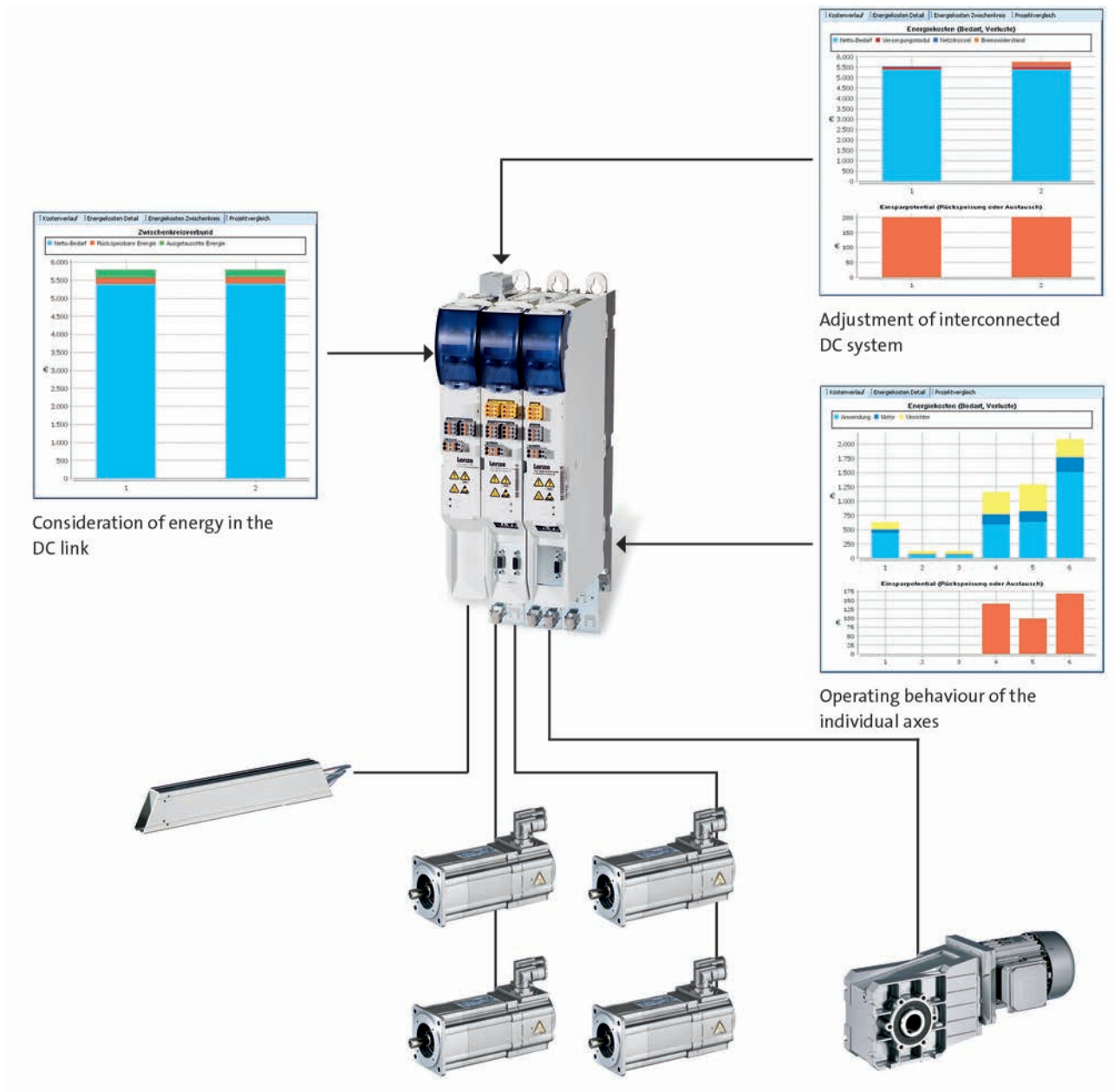

Consideration of energy in the DC link

Adjustment of interconnected DC system

Operating behaviour of the individual axes

Servo-Inverter i700

General information



Servo-Inverter i700

Technical data



Standards and operating conditions

Mode			
Product			Servo-Inverter i700
Conformity			
CE			Low-Voltage Directive 2006/95/EC
EAC			TP TC 004/2011 (TR C) TP TC 020/2011 (TR C)
Approval			
UL 508C	UL 508C		Power Conversion Equipment (file no. E132659)
CSA			CSA 22.2 No. 14
Certification			
			RoHs
Enclosure			
EN 60529			IP20
NEMA 250			Type 1
Climatic conditions			
Storage (EN 60721-3-1)			1K3 (temperature: -25 °C ... +60 °C)
Storage (EN 60721-3-1) > 6 months			1K3 (temperature: -25 °C ... +40 °C)
Transport (EN 60721-3-2)			2K3 (temperature: -25 °C ... +70 °C)
Operation (EN 60721-3-3)			3K3 (temperature: -10 °C ... +55 °C)
Current derating at over 40 °C			2.5 % / K
Site altitude			
Amsl	H _{max}	[m]	4000
Current derating at over 1000 m		[%/1000 m]	5
Vibration resistance			
Transport (EN 60721-3-2)			2M2
Operation (EN 61800-5-1)			10 Hz ≤ f ≤ 57 Hz: ±0.075 mm amplitude, 57 Hz ≤ f ≤ 150 Hz: 1.0 g
Operation (Germanischer Lloyd)			5 Hz ≤ f ≤ 13.2 Hz: ± 1 mm amplitude 13.2 Hz ≤ f ≤ 100 Hz: 0.7 g

4.6

Mode			
Product			Servo-Inverter i700
Supply form			
			Systems with earthed star point (TN and TT systems) Systems with high-resistance or isolated star point (IT systems)
Mains switching			
			Cyclic mains switching of 5 times in 5 minutes is permissible without restrictions.
Noise emission			
EN 61800-3			Cable-guided disturbance: According to category C1 with special measures According to category C2 with standard accessories According to category C3 without additional measures
Insulation resistance			
EN 61800-5-1			Overvoltage category III Above 2000 m amsl overvoltage category II
Degree of pollution			
EN 61800-5-1			2
Shock current			
EN 61800-5-1			> 3.5 mA AC, > 10 mA DC
Protective insulation of control circuits			
EN 61800-5-1			Safe mains isolation: double/reinforced insulation

Servo-Inverter i700

Technical data



Rated data for single axes

					
Max. short-time output current					
	$I_{\max, \text{out}}$	[A]	5.0	10.0	20.0
Product key			E70ACMS□0054SA1ET□	E70ACMS□0104SA1ET□	E70ACMS□0204SA1ET□
DC supply			DC 260 V -0 % ... 775 V +0 %		
	U_{DC}	[V]			
Typical motor power					
4-pole asynchronous motor	P	[kW]	0.75	1.50	4.00
Rated output current					
	$I_{\text{N, out}}$	[A]	2.5	5.0	10.0
Rated switching frequency			4		
	f_{ch}	[kHz]			
Output current					
4 kHz	I_{out}	[A]	2.5	5.0	10.0
8 kHz	I_{out}	[A]	2.5	5.0	10.0
16 kHz	I_{out}	[A]	1.5	3.0	6.0
Power loss					
	P_{V}	[W]	50.0	80.0	130

Dimensions and weights

Standard installation design

Dimensions			
Height	h	[mm]	350
Height, including fastening	h	[mm]	410
Width	b	[mm]	50
Depth	t	[mm]	261
Mass			
	m	[kg]	2.7

Servo-Inverter i700

Technical data



Rated data for single axes

					
Max. short-time output current					
	$I_{\max, \text{out}}$	[A]	32.0	48.0	64.0
Product key			E70ACMS□0324SA1ET□	E70ACMS□0484SA1ET□	E70ACMS□0644SA1ET□
DC supply			DC 260 V -0 % ... 775 V +0 %		
	U_{DC}	[V]			
Typical motor power					
4-pole asynchronous motor	P	[kW]	7.50	11.0	15.0
Rated output current					
	$I_{\text{N, out}}$	[A]	16.0	24.0	32.0
Rated switching frequency			4		
	f_{ch}	[kHz]			
Output current					
4 kHz	I_{out}	[A]	16.0	24.0	32.0
8 kHz	I_{out}	[A]	12.8	19.2	25.6
16 kHz	I_{out}	[A]	9.6	14.4	19.2
Power loss					
	P_{V}	[W]	210	290	390

4.6

Dimensions and weights

Standard installation design

Dimensions			
Height	h	[mm]	350
Height, including fastening	h	[mm]	410
Width	b	[mm]	100
Depth	t	[mm]	261
Mass			
	m	[kg]	5.2

Servo-Inverter i700

Technical data



Rated data for double axes

Max. short-time output current				
	$I_{\max, \text{out}}$	[A]	5.0	10.0
Product key			E70ACMS□0054SA2ET□	E70ACMS□0104SA2ET□
DC supply			DC 260 V -0 % ... 775 V +0 %	
	U_{DC}	[V]		
Typical motor power				
4-pole asynchronous motor	P	[kW]	0.75	1.50
Rated output current				
	$I_{\text{N, out}}$	[A]	2.5	5.0
Rated switching frequency			4	
	f_{ch}	[kHz]		
Output current				
4 kHz	I_{out}	[A]	2.5	5.0
8 kHz	I_{out}	[A]	2.5	5.0
16 kHz	I_{out}	[A]	1.5	3.0
Power loss				
	P_{V}	[W]	90.0	140

Dimensions and weights

Standard installation design

Dimensions			
Height	h	[mm]	350
Height, including fastening	h	[mm]	410
Width	b	[mm]	50
Depth	t	[mm]	261
Mass			
	m	[kg]	2.9

4.6

Servo-Inverter i700

Technical data



Rated data for double axes

				
Max. short-time output current				
	$I_{\max, \text{out}}$	[A]	20.0	32.0
Product key			E70ACMS□0204SA2ET□	E70ACMS□0324SA2ET□
DC supply			DC 260 V -0 % ... 775 V +0 %	
	U_{DC}	[V]		
Typical motor power				
4-pole asynchronous motor	P	[kW]	4.00	7.50
Rated output current				
	$I_{\text{N, out}}$	[A]	10.0	16.0
Rated switching frequency			4	
	f_{ch}	[kHz]		
Output current				
4 kHz	I_{out}	[A]	10.0	16.0
8 kHz	I_{out}	[A]	10.0	12.8
16 kHz	I_{out}	[A]	6.0	9.6
Power loss				
	P_{V}	[W]	260	370

4.6

Dimensions and weights

Standard installation design

Dimensions				
Height	h	[mm]	350	350
Width	b	[mm]	100	100
Depth	t	[mm]	261	261
Mass				
	m	[kg]	5.2	5.2



Servo-Inverter i700

Technical data



Rated data for power supply modules

► The data is valid for operation at 3/PE AC 400 V.

				
Product key				
Power supply module			E70ACPS□0304S	E70ACPS□0604S
Rated power				
With mains filter/mains choke	P_N	[kW]	15.4	30.9
Without mains filter/mains choke	P_N	[kW]	10.3	20.6
Max. short-time output power				
	$P_{max, 2}$	[kW]	20.6	41.2
Mains voltage range			3/PE AC 320 V -0% ... 528 V +0%, 45 Hz -0% ... 65 Hz +0%	
	U_{AC}	[V]		
Rated mains current				
	$I_{N, AC}$	[A]	24.5	49.0
Rated DC-bus current				
	$I_{N, DC}$	[A]	30.0	60.0
Max. DC-bus current				
	I_{max}	[A]	45.0	90.0
Power loss				
	P_V	[W]	60.0	110

Brake chopper rated data

Rated power, Brake chopper				
	P_N	[kW]	4.1	10.1
Max. output power, Brake chopper				
	$P_{max, 1}$	[kW]	26.8	65.5
Running time				
	t_{on}	[s]	15.0	
Recovery time				
	t_{re}	[s]	82.0	
Min. brake resistance				
	R_{min}	[Ω]	22.0	9.0

Dimensions and weights

Standard installation design

Dimensions				
Height	h	[mm]	350	
Height, including fastening	h	[mm]	410	
Width	b	[mm]	50	100
Depth	t	[mm]	261	
Mass				
	m	[kg]	2.8	5.8

Servo-Inverter i700

Technical data



Servo-Inverter i700

Technical data



"Cold plate" design

Inverters in cold-plate design dissipate some of their waste heat (heat loss) via a cooler adapted to the application. For this purpose, the inverters are provided with a planed cooling plate which is connected to a separate cooler in a thermally conductive way. Using the cold plate technology, the main part of the heat energy can be transferred directly to the external cooling units.

The use of cold-plate technology is advantageous for the following application cases:

- Minimising the expense of cooling the control cabinet. Here, the main part of the power loss is directly transferred to a cooling unit outside of the control cabinet, e.g. convection cooler or water cooler.
- Heavily polluted ambient air or control cabinets with a high degree of protection which do not allow for a use of a forced air cooling of the control cabinets.
- Low mounting depth in the control cabinet.

Requirements for the cooler

When cold-plate technology is used, the following basic conditions must be considered:

- Good thermal connection to the external cooling unit, i.e. the implementation of the heat transfer resistance (R_{th}) according to the power loss.
- The contact surface must at least be as big as the cooling plate of the inverter.
- The planarity of the contact surface must not exceed 0.05 mm.
- The contact surface of the external coolers and cooling plate must be connected by means of the intended screwed connection.
- The maximum temperature of the cooling plate of the inverter ((75 °C) must not be exceeded.

Single axes

Product key	Power to be dissipated	Thermal resistance
Inverter	P_V	R_{th}
	[W]	[K/W]
E70ACMS□0054SA1ET□	25.0	≤ 1.6
E70ACMS□0104SA1ET□	50.0	≤ 0.8
E70ACMS□0204SA1ET□	95.0	≤ 0.45
E70ACMS□0324SA1ET□	140	≤ 0.25
E70ACMS□0484SA1ET□	215	≤ 0.2
E70ACMS□0644SA1ET□	290	≤ 0.15

Double axes

Product key	Power to be dissipated	Thermal resistance
Inverter	P_V	R_{th}
	[W]	[K/W]
E70ACMS□0054SA2ET□	50.0	≤ 0.8
E70ACMS□0104SA2ET□	95.0	≤ 0.45
E70ACMS□0204SA2ET□	185	≤ 0.2
E70ACMS□0324SA2ET□	275	≤ 0.15

Power supply modules

Product key	Power to be dissipated	Thermal resistance
Power supply module	P_V	R_{th}
	[W]	[K/W]
E70ACPS□0304S	45.0	≤ 0.95
E70ACPS□0604S	85.0	≤ 0.45

Servo-Inverter i700

Technical data



"Cold plate" design

Dimensions and weights

Single axes

Product key			E70ACMS□0054SA1ET□	E70ACMS□0104SA1ET□	E70ACMS□0204SA1ET□
Dimensions					
Height, including fastening	h	[mm]	410		
Width	b	[mm]	50		
Depth	t	[mm]	221		
Mass					
	m	[kg]	2.3		

Product key			E70ACMS□0324SA1ET□	E70ACMS□0484SA1ET□	E70ACMS□0644SA1ET□
Dimensions					
Height, including fastening	h	[mm]	410		
Width	b	[mm]	100		
Depth	t	[mm]	221		
Mass					
	m	[kg]	5.3		

4.6

Double axes

Product key			E70ACMS□0054SA2ET□	E70ACMS□0104SA2ET□	E70ACMS□0204SA2ET□	E70ACMS□0324SA2ET□
Dimensions						
Height, including fastening	h	[mm]	410			
Width	b	[mm]	50			100
Depth	t	[mm]	221			
Mass						
	m	[kg]	2.5			5.3

Power supply modules

Product key			E70ACPS□0304S	E70ACPS□0604S
Dimensions				
Height, including fastening	h	[mm]	410	
Width	b	[mm]	50	100
Depth	t	[mm]	221	
Mass				
	m	[kg]	2.6	5.6

Servo-Inverter i700

Technical data



Push-through technique design

The inverters in push-through design reduce the waste heat in the control cabinet.

The inverter is mounted in the control cabinet so that the heatsink on the inverter is outside the control cabinet. Thus, the entire waste heat can be dissipated outside the control cabinet via convection or forced air cooling for almost all device performances.

Using the push-through technology is advantageous in the following application cases:

- Minimising the expense for control cabinet cooling. For this purpose, the main part of the power loss is directly transferred to the ambience outside the control cabinet, e.g. convection cooling.
- In case of control cabinets with a high degree of protection > IP54 by using separate mounting and cooling areas.
- Low mounting depth in the control cabinet.

Single axes

Product key	Power to be dissipated
Inverter	
	P_V
	[W]
E70ACMS□0054SA1ET□	25.0
E70ACMS□0104SA1ET□	50.0
E70ACMS□0204SA1ET□	95.0
E70ACMS□0324SA1ET□	140
E70ACMS□0484SA1ET□	215
E70ACMS□0644SA1ET□	290

Double axes

Product key	Power to be dissipated
Inverter	
	P_V
	[W]
E70ACMS□0054SA2ET□	50.0
E70ACMS□0104SA2ET□	95.0
E70ACMS□0204SA2ET□	185
E70ACMS□0324SA2ET□	275

Power supply modules

Product key	Power to be dissipated
Power supply module	
	P_V
	[W]
E70ACPS□0304S	45.0
E70ACPS□0604S	85.0

Servo-Inverter i700

Technical data



Push-through technique design

Dimensions and weights

Single axes

Product key			E70ACMS□0054SA1ET□	E70ACMS□0104SA1ET□	E70ACMS□0204SA1ET□
Dimensions					
Height, including fastening	h	[mm]	410		
Width	b	[mm]	50		
Depth (in control cabinet)	t	[mm]	221		
Mass					
	m	[kg]	3.0		

Product key			E70ACMS□0324SA1ET□	E70ACMS□0484SA1ET□	E70ACMS□0644SA1ET□
Dimensions					
Height, including fastening	h	[mm]	410		
Width	b	[mm]	100		
Depth (in control cabinet)	t	[mm]	221		
Mass					
	m	[kg]	7.1		

4.6

Double axes

Product key			E70ACMS□0054SA2ET□	E70ACMS□0104SA2ET□	E70ACMS□0204SA2ET□	E70ACMS□0324SA2ET□
Dimensions						
Height, including fastening	h	[mm]	410			
Width	b	[mm]	50			100
Depth	t	[mm]	261			
Mass						
	m	[kg]	3.2			7.1

Power supply modules

Product key			E70ACPS□0304S	E70ACPS□0604S
Dimensions				
Height, including fastening	h	[mm]	410	
Width	b	[mm]	50	100
Depth (in control cabinet)	t	[mm]	221	
Mass				
	m	[kg]	2.8	5.8

Servo-Inverter i700

Technical data



Servo-Inverter i700

Interfaces



Mains connection

Interference voltage categories according to the European standard EN 61800-3 are divided into category C1, C2 and the category C3.

Category C1



- Describes the use in public networks.

Category C2

- Describes the use of devices intended for industrial purposes in areas also comprising residential areas.



Category C3

- Describes the use of devices intended for industrial purposes only.

  26 - The interference voltage categories achievable due to the filter measures are shown in conjunction with the motor cables.

With an upstream mains choke or mains filter, the maximum continuous power of the power supply modules can be used since the effective current will be reduced.

If no filter or an RFI filter is used, the permissible continuous power (rated power) of the power supply module is reduced. The mains choke and the RFI filter can also be combined without any restrictions.

  35 - Mains chokes, RFI filters, Mains filters

Mains fuses and cable cross-sections

- ▶ The mains fuse and cable cross-section specifications are for a mains connection of 3AC 400 V or 3AC 480 V.
- ▶ Class gG/gI fuses or class gRL semiconductor fuses.
- ▶ The cable cross-sections apply to PVC-insulated copper cables.
- ▶ Use for installation with UL-approved cables, fuses and brackets.

4.6

Rated power	Mains voltage	Product key	Circuit breaker	Fuse		Mains connection
				EN 60204-1	UL ¹⁾	
P_N	U_{AC}	Power supply module	I	I	I	Cross-section (with mains choke)
[kW]	[V]		[A]	[A]	[A]	q
15.4	3 AC 320 ...	E70ACPS□0304S	C40	40		10.0
30.9	528	E70ACPS□0604S	C63	63		16.0

¹⁾ In preparation.



Motor connection

- ▶ Electric strength of the motor cable: 1 kV as per VDE 250-1.
- ▶ Keep motor cables as short as possible, as this has a positive effect on the drive behaviour.
- ▶ Maximum motor cable length 50 m per axis.
- ▶ With group drives (multiple motors on one inverter), the resulting cable length is the key factor. This can be calculated using the hardware manual.

Motor cable lengths and interference voltage categories

When using the i700 system, use external filters to comply with the EMC Directives.

Category C1

- With special measures; please contact your Lenze sales office.

Category C2

- With RFI filters, 6 axes with 50 m motor cable
- With mains filters, 10 axes with 50 m motor cable

Category C3

- Without external measures, 4 axes with 50 m motor cable
- With mains choke, 10 axes with 50 m motor cable



35 - Mains chokes, RFI filters, Mains filters



Motor connection

The following diagrams show the possible number of axes and the possible sum of motor cable lengths to ensure compliance with interference suppression according to the categories.

- Number of axes (n) / sum of the motor cable length (l)

Category C2

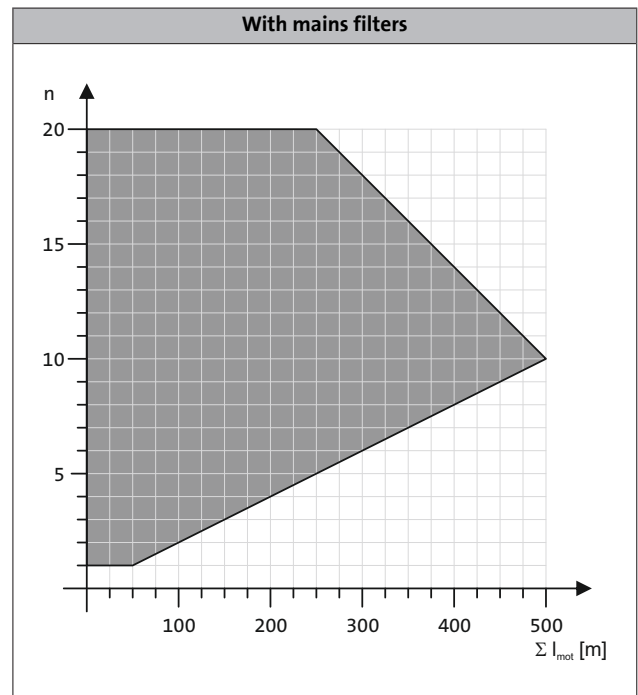
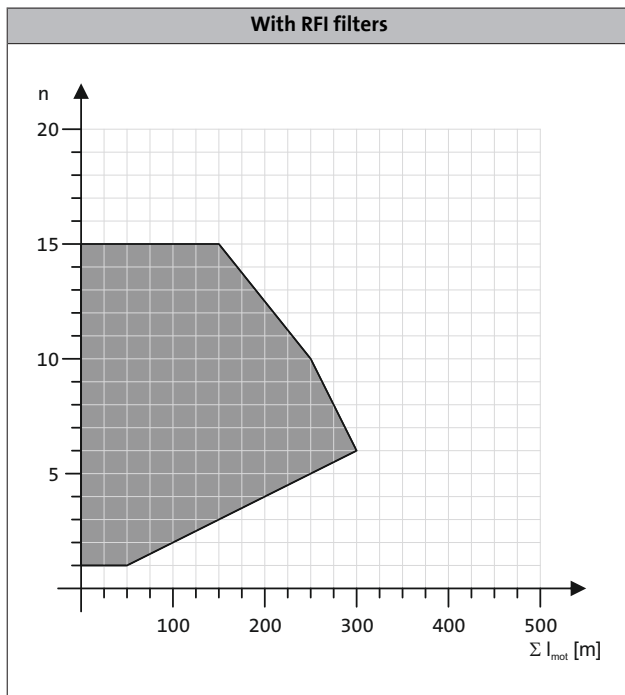

4.6

Category C3

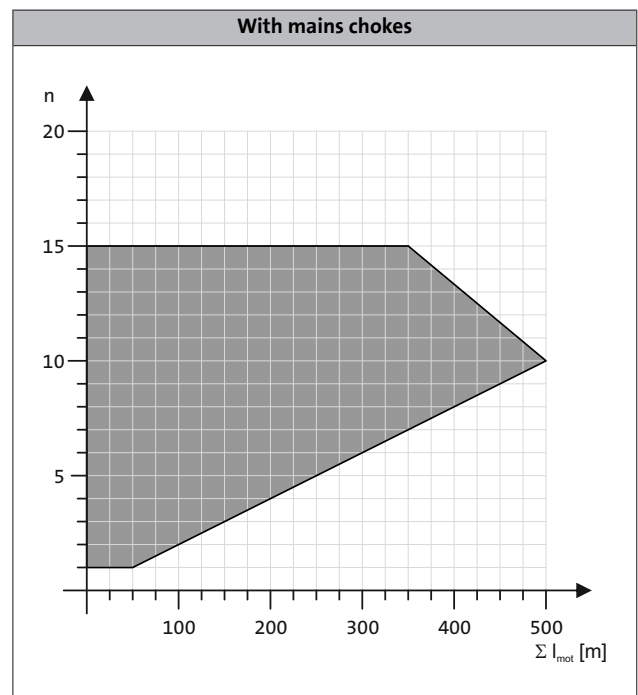
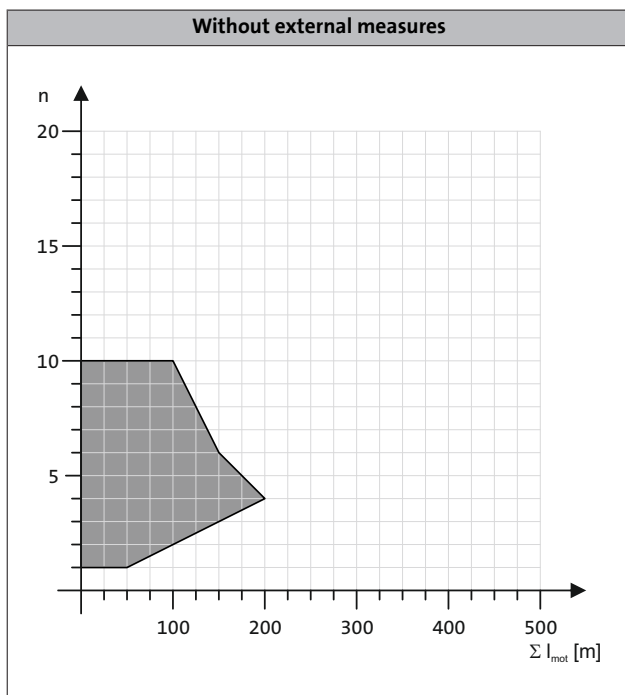



Connection diagrams

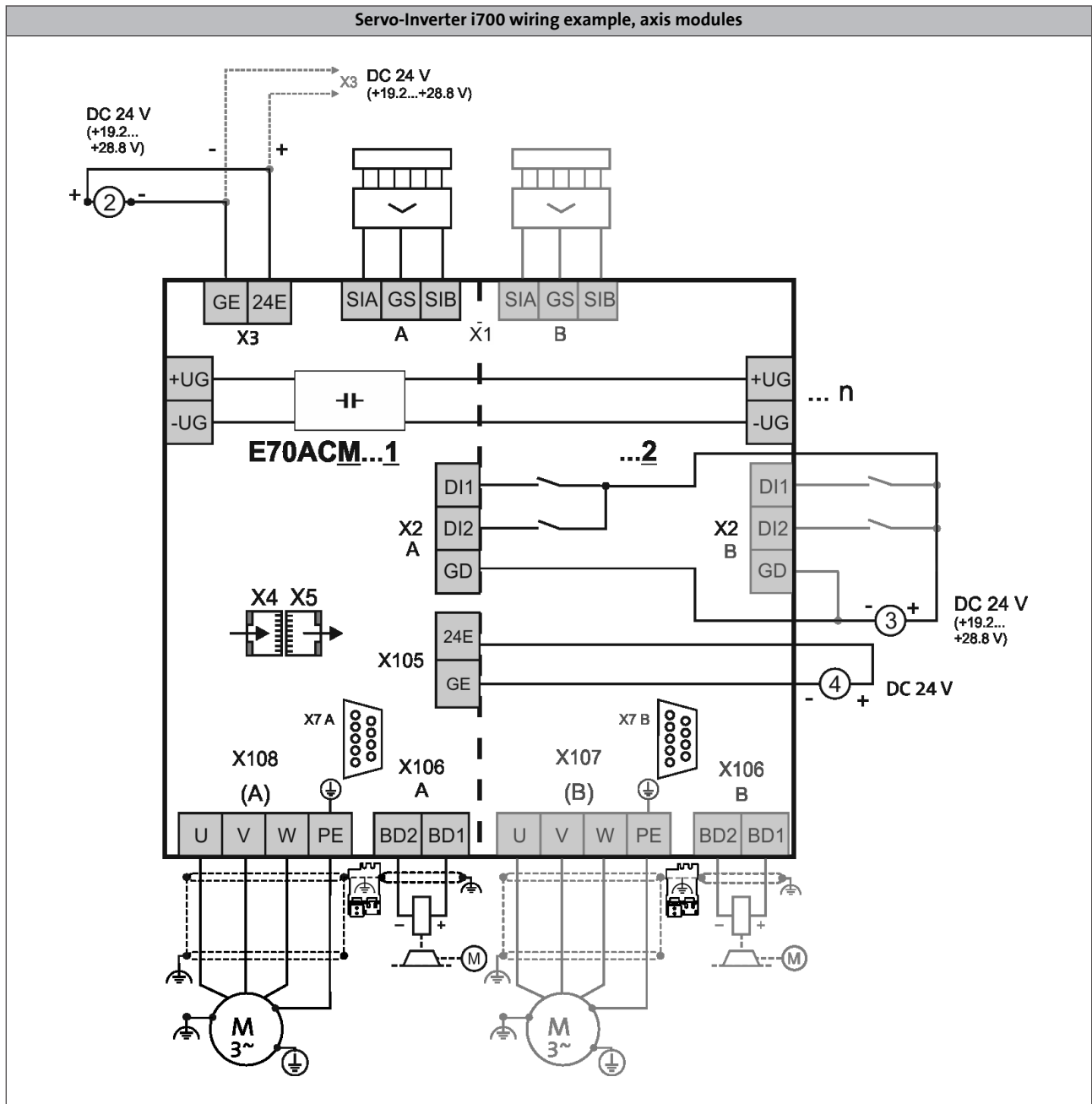

- [2] 24 supply for control electronics
- [3] 24 V supply for digital inputs
- [4] 24 V supply for motor holding brake(s)

4.6



Connection diagrams

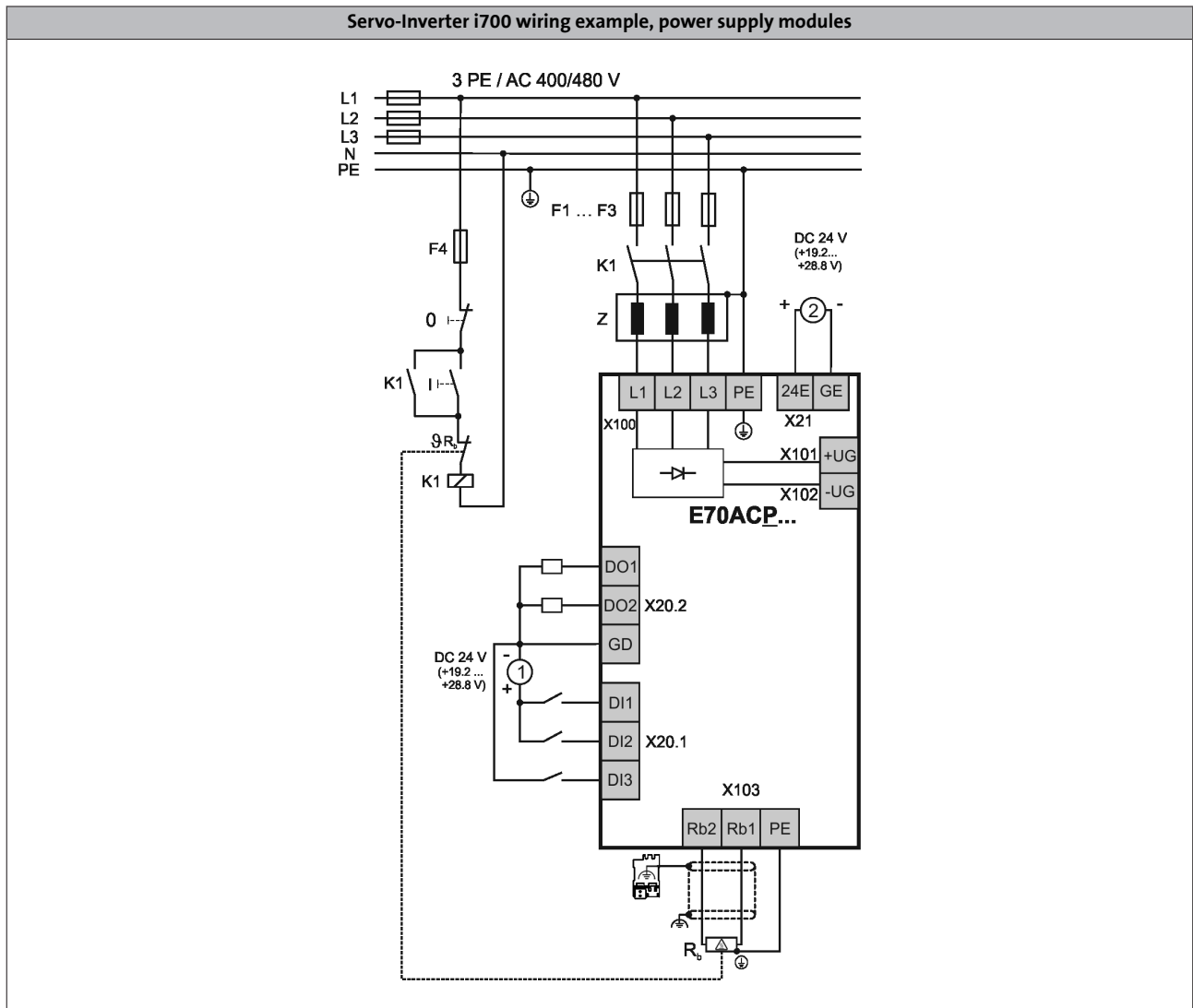

- [1] 24 V supply for digital inputs
- [2] 24 V supply for control electronics



Control connections

Mode	Servo-Inverter i700
Digital inputs	
Number	2
Touch-probe-capable	2 with time and position stamp
Switching level	PLC (IEC 61131-2)
Max. input current	8 mA
External DC supply	
Rated voltage	24 V in accordance with IEC 61131-2
Voltage range	19.2 ... 28.8 V, max. residual ripple $\pm 5\%$
Interfaces	
EtherCAT	2 (in/out)
Safety engineering	Safe torque off (STO) 2 channel design
Drive interface	
Resolver input	Sub-D, 9-pin
Encoder input	Sub-D, 15-pin SinCos absolute value encoder single-turn (with zero pulse) or multi-turn (Hiperface®)
Motor brake	24V holding brake per axis can be directly controlled

4.6

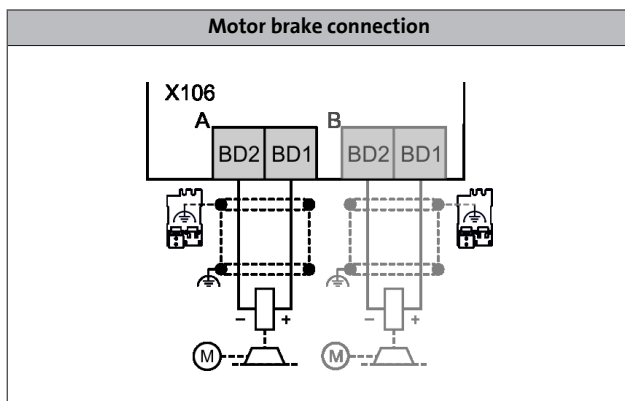
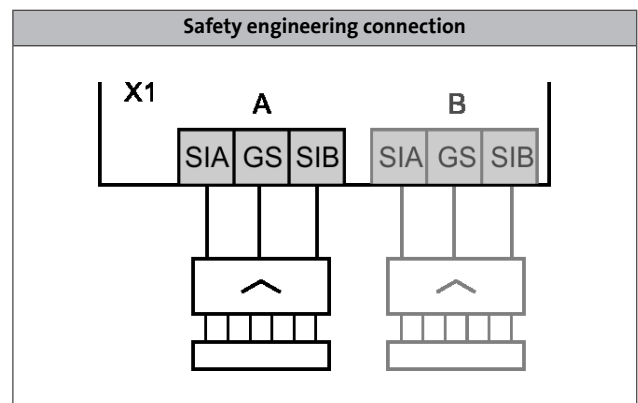
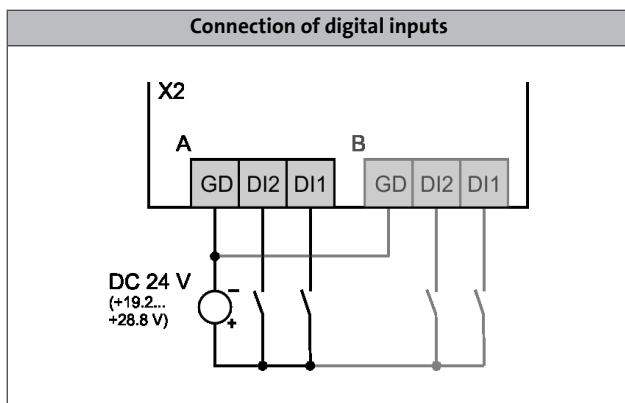

Servo-Inverter i700



Interfaces



Control connections

External 24 V supply

The control electronics of the Servo-Inverter i700 has to be supplied with an external 24-V supply. For this purpose, Lenze provides power supply units. The following table shows the corresponding current consumptions of the devices.

  38 - 24 V power supply unit

Single axes

Max. short-time output current	Product key	External DC supply
		Current
$I_{\max, \text{out}}$		
[A]		
5.0	E70ACMS□0054SA1ET□	1.0 A
10.0	E70ACMS□0104SA1ET□	
20.0	E70ACMS□0204SA1ET□	
32.0	E70ACMS□0324SA1ET□	2.0 A
48.0	E70ACMS□0484SA1ET□	
64.0	E70ACMS□0644SA1ET□	

4.6

Double axes

Max. short-time output current	Product key	External DC supply
		Current
$I_{\max, \text{out}}$		
[A]		
5.0	E70ACMS□0054SA2ET□	1.0 A
10.0	E70ACMS□0104SA2ET□	
20.0	E70ACMS□0204SA2ET□	2.0 A
32.0	E70ACMS□0324SA2ET□	

Servo-Inverter i700

Interfaces



Safety system (STO)

By default, the Servo-Inverter i700 are available with the "safe torque off, STO" safety function. This helps reduce the control system costs, save space in the control cabinet and keep wiring to a minimum. The safety engineering is certified according to EN ISO 13849-1 (Cat. 4, PL e), EN 61508/EN 62061 (SIL 3). A "safe stop 1, SS1" can be implemented easily using a safety switching device.

The product key of the inverter has an "A" as the 14th character. For example, a servo inverter 5A, built-in unit with safety engineering would be: E70ACMSE0054SAETR



Double axis with connections for safety engineering

Servo-Inverter i700

Interfaces



EtherCAT® communication

EtherCAT enables the Servo-Inverter i700 to be controlled with digital control signals via the EtherCAT® bus system. It is integrated in the Servo-Inverter i700. It can be seen in the product key at the positions 16 and 17: E70ACM□□□□4SA□ET□.

The advantages of the system are:

- quick and very powerful bus system
- ideally suited for Controller-based Automation solutions
- easy system integration since a wide range of sensors and actuator is available on the market.
- the basic features of a servo drive are available in the axes according to the device profile and can be easily used via the EtherCAT®.

Mode	Features
Communication	
EtherCAT ¹⁾	<ul style="list-style-type: none"> • CANopen over EtherCAT (CoE) • Distributed clock • 2 RJ45 connections with LEDs for link and activity

¹⁾ EtherCAT® is a registered trademark and patented technology, licensed by Beckhoff Automation GmbH, Germany.

Technical data

Product key			E70ACM□□□□4SAxET□
Communication			
Medium			CAT5e S/FTP according to ISO/ICE11801 (2002)
Communication profile			CoE (CANopen over EtherCAT)
Baud rate			
	b	[MBit/s]	100
Node			
			Slave
Network topology			
			Line (internal ring)
Number of logical process data channels			
			1
Process data words (PZD)			
16 Bit			1 ... 32
Number of bus nodes			
			Max. 65535
Max. cable length			
between two nodes	I_{max}	[m]	100
Rated voltage			
	$U_{N,DC}$	[V]	24.0

Servo-Inverter i700

Accessories



Brake resistors for power supply modules

The assignment of brake resistors to the power supply modules is shown in the following tables.



Brake resistor 27 ohms

Product key		Rated resistance	Rated power	Thermal capacity	Dimensions	Mass
Power supply module	Brake resistor	R_N	P_N	C_{th}	$h \times b \times t$	m
		[Ω]	[kW]	[KWs]	[mm]	[kg]
E70ACPS□0304S	ERBP027R200W	27.0	200.0	30.0	320 x 41 x 122	1.0
	ERBS027R600W		600.0	90.0	550 x 110 x 105	3.1
	ERBS027R01K2		1200.0	180	1020 x 110 x 105	5.6
E70ACPS□0604S	ERBG012R01K9	12.0	1900.0	285	486 x 236 x 302	13.0
	ERBG012R05K2		5200.0	750	486 x 426 x 302	28.0

Servo-Inverter i700

Accessories



Mains chokes for power supply modules

A mains choke is an inductive resistor which is connected in the mains cable of the power supply module. The use of a mains choke provides the following advantages:

- **Fewer effects on the mains:**
The wave form of the mains current is a close approximation to a sine wave.
- **Reduction in the effective mains current:**
Reduction of mains, cable and fuse loads
- **Current balancing of power supply modules connected in parallel**

Mains chokes can be used without restrictions in conjunction with RFI filters.

Please note:

The use of a mains choke slightly reduces the mains voltage at the input of the power supply module – the typical voltage drop across the mains choke at the rated values is around 5%.

The selection of the correct mains chokes for the power supply modules depends on the number of connected axes. For this purpose, different mains chokes are available. For the following efficiencies of the power supply modules, we have dimensioned model mains chokes:

- Power supply modules for 30 A operation with rated data
- Power supply modules for 60 A operation with rated data



Mains choke

Product key		Output power	Rated current	Dimensions	Mass
Power supply module	Mains choke	at 400 V			
		P_{out}	I_N	$h \times b \times t$	m
		[kW]	[A]	[mm]	[kg]
E70ACPS□0304S	EZAELN3025B122	15.4	25.0	110 x 155 x 167	5.8
E70ACPS□0604S	EZAELN3050B591	30.9	50.0	112 x 185 x 208	8.4

The following diagram shows the possible number of axes and the possible sum of motor cable lengths to ensure compliance with interference suppression according to category C3.

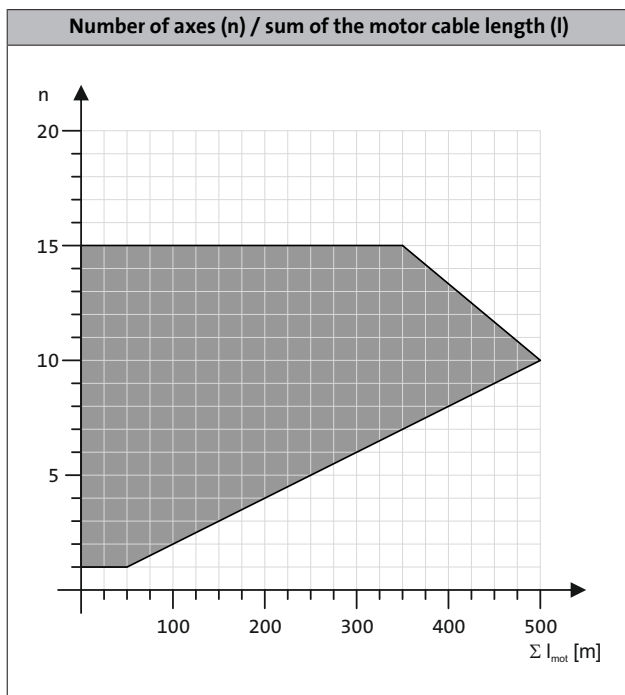

Servo-Inverter i700

Accessories



Interference suppression of power supply modules

RFI filters

RFI filters are primarily capacitive accessory components which can be connected directly upstream from the power supply modules. This measure enables compliance with the corresponding conducted noise emission requirements according to EN 61800-3.



RFI filter, can be mounted beside the power supply module

4.6

Product key		Output power	Rated current	Power loss	Max. cable length	Dimensions	Mass
Power supply module	RFI filter	at 400 V			Reference group C2		
		P_{out}	I_N	P_V	l_{max}	$h \times b \times t$	m
		[kW]	[A]	[kW]	[m]	[mm]	[kg]
E70ACPS□0304S	E94AZRP0084	3.60	8.00	20.0	6 axes of 50 m each	485 x 60 x 261	4.2
	E94AZRP0294	10.3	29.0	50.0			4.5
E70ACPS□0604S	E94AZRP0824	20.6	82.0	80.0		490 x 209 x 272	18.5

The following diagram shows the possible number of axes and the possible sum of motor cable lengths to ensure compliance with interference suppression according to category C2.

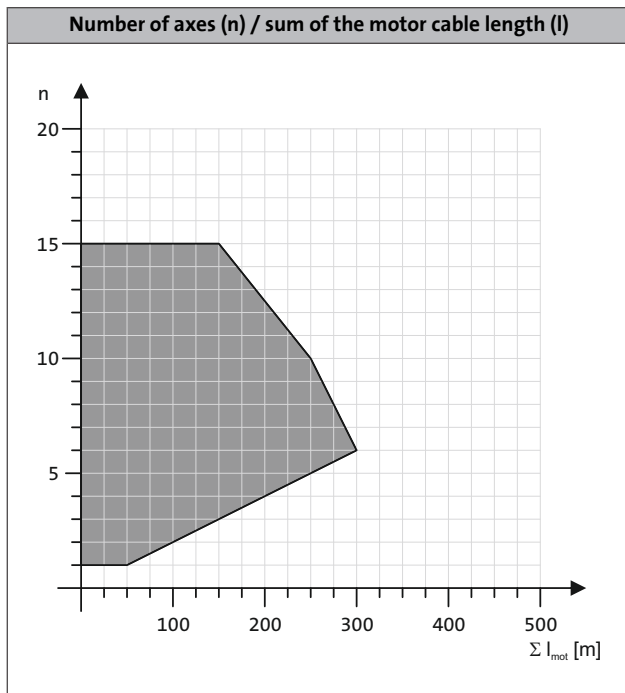



Interference suppression of power supply modules

Mains filters

A mains filter is a combination of mains choke and RFI filter in one housing. It reduces the conducted interference emission into the mains in order that the conducted interference voltage is reduced to the area permissible according to EN61800-3.

This results in the following advantages:

- Fewer effects on the mains:
The wave form of the mains current is a close approximation to a sine wave.
- Reduction in the effective mains current:
Reduction of mains, cable and fuse loads
- Current balancing when power supply modules are connected in parallel

Product key		Output power	Rated current	Voltage drop	Max. cable length	Dimensions	Mass
Power supply module	Mains filter	at 400 V			Reference group C2		
		P_{out}	I_N	U	I_{max}	h x b x t	m
		[kW]	[A]	[V]	[m]	[mm]	[kg]
E70ACPS□0304S	E94AZMP0084	4.90	8.00	10.0	10 axes of 50 m each	485 x 90 x 261	8.6
	E94AZMP0294	15.4	29.0	7.3		485 x 120 x 261	16.5
E70ACPS□0604S	E94AZMP0824	30.6	82.0	6.4		490 x 270 x 272	29.0

4.6

The following diagram shows the possible number of axes and the possible sum of motor cable lengths to ensure compliance with interference suppression according to category C2.

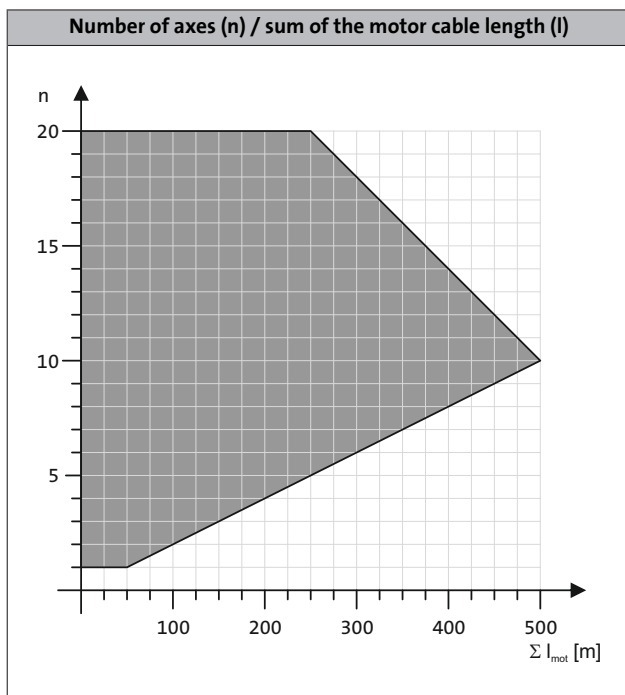

Servo-Inverter i700

Accessories



24 V power supply unit

The control electronics of the axis and power supply modules must be supplied by external 24-V power supply units. For this purpose, various power supply units are available. The power supply units can be supplied with AC voltage and DC voltage from the DC bus of the drive system. This ensures a continuous supply of the electronics in case of mains failure to ensure a controlled braking process.

Electrical isolation

The i700 components have a "safe separation" between mains and electronic potential according to IEC 61131-2. For maintaining this feature, the successive power supply units can be used with SELV (Safety Extra Low Voltage) or PELV (Protective Extra Low Voltage).



24 V power supply unit

Product key			EZV1200-000	EZV2400-000	EZV4800-000	EZV1200-001	EZV2400-001	EZV4800-001
Rated voltage								
AC	$U_{N,AC}$	[V]	230			400		
Input voltage								
	U_{in}	[V]	AC 85 ... 264 DC 90 ... 350			AC 320 ... 575 DC 450 ... 800		
Rated mains current								
	$I_{N,AC}$	[A]	0.8	1.2	2.3	0.3	0.6	1.0
Output voltage								
	U_{out}	[V]	DC 22.5 ... 28.5					
Rated output current								
	$I_{N,out}$	[A]	5.0	10.0	20.0	5.0	10.0	20.0
Dimensions								
Height	h	[mm]	130					
Width	b	[mm]	55	85	157	73	85	160
Depth	t	[mm]	125					
Mass								
	m	[kg]	0.8	1.2	2.5	1.0	1.1	1.9

4.6

Installation sets for Servo-Inverter i700

The installation sets include:

- All plug-in terminals
- Shield sheets plus shield terminals
- EtherCAT® cable (100 mm) for connecting the next axis

Mode	Features	Product key
Installation set for single axes	• For axes 5 to 20 A	E70AZEVK001
	• For axes 32 to 64 A	E70AZEVK003
Installation set for double axes	• For axes 5 to 10 A	E70AZEVK002
	• For axes 20 to 32 A	E70AZEVK004
Installation set for power supply modules	• For power supply module 30 A	E70AZEVK005
	• For power supply module 60 A	E70AZEVK006
	• For parallel connection	E70AZEVK007

Servo-Inverter i700

Accessories



Servo-Inverter i700

Accessories



15593803

Lenze SE
Hans-Lenze-Straße 1
D-31855 Aenzen
Phone: +49 (0)5154 82-0
Telefax: +49 (0)5154 82 28 00

www.Lenze.com

Lenze